



Ceiling AP Series

User Guide

Copyright Statement

© 2019 Shenzhen Tenda Technology Co., Ltd. All rights reserved.

Tenda is a registered trademark legally held by Shenzhen Tenda Technology Co., Ltd. Other brand and product names mentioned herein are trademarks or registered trademarks of their respective holders. Copyright of the whole product as integration, including its accessories and software, belongs to Shenzhen Tenda Technology Co., Ltd. No part of this publication can be reproduced, transmitted, transcribed, stored in a retrieval system, or translated into any language in any form or by any means without the prior written permission of Shenzhen Tenda Technology Co., Ltd.

Disclaimer

Pictures, images and product specifications herein are for references only. To improve internal design, operational function, and/or reliability, Tenda reserves the right to make changes to the products without obligation to notify any person or organization of such revisions or changes. Tenda does not assume any liability that may occur due to the use or application of the product described herein. Every effort has been made in the preparation of this document to ensure accuracy of the contents, but all statements, information and recommendations in this document do not constitute a warranty of any kind, express or implied.

Preface



Thank you for choosing Tenda! Please read this user guide before you start.

Conventions

The typographical elements that may be found in this document are defined as follows.

Item	Presentation	Example
Cascading menus	>	Internet Settings > LAN Setup
Parameter and value	Bold	Set SSID to Tom .
Variable	Italic	Format: <i>XX:XX:XX:XX:XX:XX</i>
UI control	Bold	On the Quick Setup page, click the Save button.

The symbols that may be found in this document are defined as follows.

Symbol	Meaning
 NOTE	This format is used to highlight information of importance or special interest. Ignoring this type of note may result in ineffective configurations, loss of data or damage to device.
 TIP	This format is used to highlight a procedure that will save time or resources.

Acronyms and Abbreviations

Acronym or Abbreviation	Full Spelling
AC	Access Controller (Network Equipment)
AC	Access Category (WMM settings)
ACK	Acknowledge
AES	Advanced Encryption Standard
AIFSN	Arbitration Inter Frame Spacing Number
AP	Access Point
APSD	Automatic Power Save Delivery
ARP	Address Resolution Protocol
BE	Best Effort
BK	Background

Acronym or Abbreviation	Full Spelling
CAT5e	Category 5 Ethernet
CSMA/CA	Carrier Sense Multiple Access with Collision Avoidance
CTS	Clear To Send
Cwmax	Contention Window Maximum
Cwmin	Contention Window Minimum
DHCP	Dynamic Host Configuration Protocol
DIFS	Distributed Inter-Frame Spacing
DNS	Domain Name Server
DTIM	Delivery Traffic Indication Message
EDCA	Enhanced Distributed Channel Access
GI	Guard Interval
IP	Internet Protocol
ISP	Internet Service Provider
LAN	Local Area Network
MAC	Medium Access Control
MIB	Management Information Base
MU-MIMO	Multi-User Multiple-Input Multiple-Output
NMS	Network Management System
NTS	Network Time Server
OID	Object Identifier
PoE	Power-over-Ethernet
PPP	Point to Point Protocol
PVID	Port-based VLAN ID
QVLAN	IEEE 802.11q VLAN
RADIUS	Remote Authentication Dial-In User Service
RF	Radio Frequency
RSSI	Received Signal Strength Indicator

Acronym or Abbreviation	Full Spelling
RTS	Request To Send
SNMP	Simple Network Management Protocol
SSID	Service Set Identifier
STA	Station
SYS	System
TCP/IP	Transmission Control Protocol/Internet Protocol
TKIP	Temporal Key Integrity Protocol
TXOP	Transmission Opportunity
UI	User Interface
UTF-8	8-bit Unicode Transformation Format
VI	Video Stream
VID	Virtual ID
VLAN	Virtual Local Area Network
VO	Voice Stream
WAN	Wide Area Network
WEP	Wired Equivalent Privacy
WMF	Wireless Multicast Forwarding
WMM	Wi-Fi Multimedia
WPA	Wi-Fi Protected Access
WPA-PSK	Wi-Fi Protected Access-Pre-shared Key

Technical Support

If you need more help, contact us by any of the following means. We will be glad to assist you as soon as possible.



Hotline

Global: (86) 755-27657180

(China Time Zone)

United States: 1-800-570-5892

(Toll Free: Daily-9am to 6pm PST)

Canada: 1-888-998-8966

(Toll Free: Mon - Fri 9 am - 6 pm PST)

Hong Kong: 00852-81931998



Email

support@tenda.com.cn



Website

<http://www.tendacn.com>

Contents

1	Login.....	1
1.1	Logging in to the web UI of the AP	1
1.2	Logging out.....	2
1.3	Web UI layout.....	3
1.4	Frequently-used buttons.....	4
2	Status	5
2.1	System status	5
2.2	Wireless status	7
2.3	Traffic statistics.....	9
2.4	Client list.....	10
3	Working mode.....	12
3.1	AP mode (default mode).....	12
3.1.1	Typical network topology.....	12
3.1.2	Getting familiar with AP mode configuration page	13
3.1.3	Configuring AP mode	13
3.2	Client+AP mode	15
3.2.1	Typical network topology.....	15
3.2.2	Getting familiar with Client+AP mode configuration page.....	16
3.2.3	Configuring Client+AP mode.....	17
4	Internet settings.....	19
4.1	LAN setup.....	19
4.1.1	Overview	19
4.1.2	Configuring the AP to obtain IP address automatically (for multiple APs)	21
4.1.3	Configuring the AP to use static IP address (for few APs).....	22
4.2	DHCP server	23
4.2.1	Overview	23

4.2.2	Configuring DHCP server of the AP	24
4.2.3	Viewing DHCP clients	25
5	Wireless.....	26
5.1	SSID	26
5.1.1	Overview	26
5.1.2	Modifying SSID-related parameters.....	31
5.1.3	Example of configuring a WiFi network encrypted by WPA or WPA2	33
5.2	RF settings.....	50
5.2.1	Overview	50
5.2.2	Configuring RF settings	52
5.3	RF optimization	53
5.3.1	Overview	53
5.3.2	Modifying radio optimization settings.....	56
5.4	Frequency analysis.....	57
5.4.1	Viewing frequency analysis.....	57
5.4.2	Excuting channel scan	57
5.5	WMM	59
5.5.1	Overview	59
5.5.2	Configuring scenario-based WMM settings	60
5.5.3	Configuring WMM settings manually	61
5.6	Access control	63
5.6.1	Overview	63
5.6.2	Configuring access control	64
5.7	Advanced settings	66
5.7.1	Identify client type	66
5.7.2	Broadcast packet filter	67
5.8	QVLAN settings	68
5.8.1	Overview	68
5.8.2	Example of configuring QVLAN	69

6	Advanced.....	73
6.1	Deployment mode	73
6.1.1	Applicable scenarios	73
6.1.2	Introduction to deployment mode of the AP	74
6.1.3	Configuring the cloud deployment mode.....	75
6.2	SNMP.....	76
6.2.1	Overview	76
6.2.2	Configuring the SNMP function	78
6.2.3	Example of configuring SNMP settings	79
7	Tools	81
7.1	Date & time	81
7.1.1	Overview	81
7.1.2	Configuring system time	82
7.1.3	Configuring login timeout interval.....	83
7.2	Maintenance	85
7.2.1	Reboot.....	85
7.2.2	Reset.....	87
7.2.3	Upgrade firmware	88
7.2.4	Backup and restoring configurations	89
7.2.5	LED indicator control.....	90
7.3	Account	91
7.3.1	Overview	91
7.3.2	Modifying login password.....	91
7.4	System Log	92
7.4.1	Viewing system logs	92
7.4.2	Modifying number of logs to be displayed on Web UI	93
7.4.3	Sync system logs of the AP to a log server.....	93
7.5	Diagnostic tool	95
7.5.1	Overview	95

7.5.2 Executing Ping command to detect connection quality	95
7.6 Uplink check.....	97
7.6.1 Overview	97
7.6.2 Configuring uplink detection	97
Appendix	99
A.1 Configuring a static IP address for your computer (Example: Windows 7)	99
A.2 FAQ.....	104
A.3 Default parameter values	105

1 Login

1.1 Logging in to the web UI of the AP

Before you start, ensure that:

- The AP is properly connected to a computer with an Ethernet cable.
- The IP address of the management computer is in the same network segment of the AP. For example, if the IP address of the AP is 192.168.0.254, the management computer should be configured with an IP address of 192.168.0.X (X: 2~253). For how to configure the computer with a specified IP address, see [A.1 in Appendix](#).

Procedure

- Step 1** Start a web browser on the computer, enter the IP address of the AP (default: **192.168.0.254**) in the address bar, and press **Enter** (Windows) or **Return** (Mac) on the keyboard.

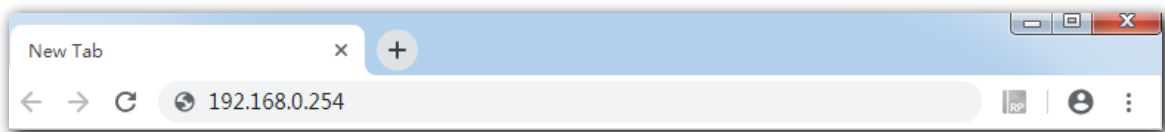

NOTE

How to obtain the login IP address:

- The default login IP address is **192.168.0.254**, which could be found on the rear panel of the AP. You are recommended to note it down and keep it safely for later use.
- If the AP is managed by an Tenda AC (access controller) or an Tenda router with AP functionality, the IP address of the AP is assigned by the management Tenda AC or router. To obtain it, go to the web UI of the AC or the router to view the new IP address of the AP.

- Step 2** Enter the login user name and password (default: **admin/admin**), and click **Login**.

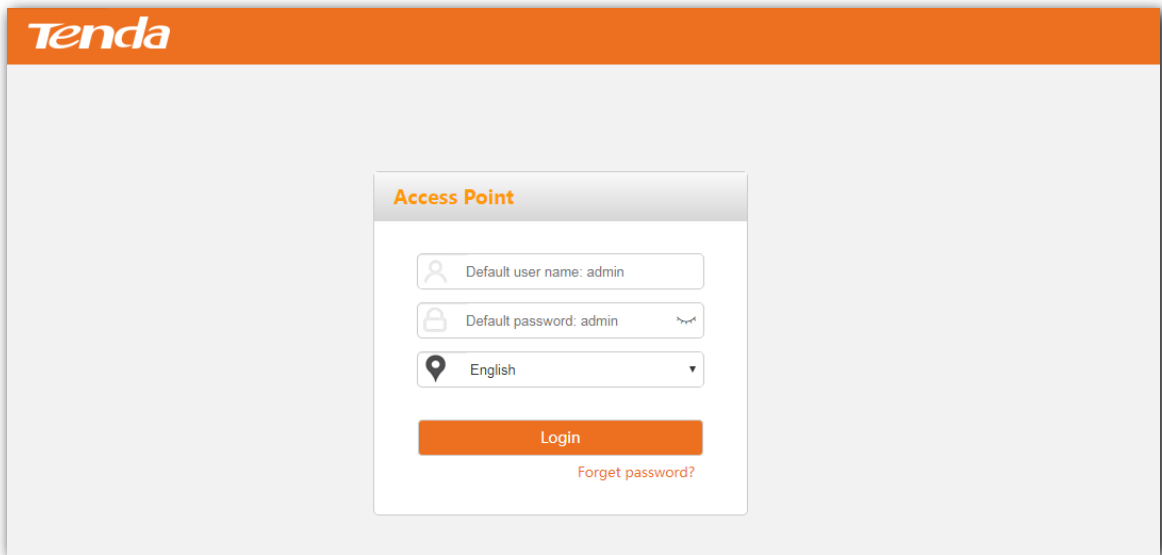

- If the login page does not appear, refer to [Q1 in A.2 FAQ](#).
- To modify the login user name and password, see [Account](#).

---- End

1.2 Logging out

The system logs you out when you:

- Close the web browser.
- Log in to the web UI of the AP but perform no operation within the **Login Timeout Interval** (default: 5 minutes).



Login Time Interval allows you to set how long you can stay on the web UI, which could be modified by navigating to **Tools > Date & Time > Login Timeout Interval**.

1.3 Web UI layout

The web UI of the AP consists of four sections, including the level-1, and level-2 navigation bars, tab page area, and the configuration area. See the following figure.

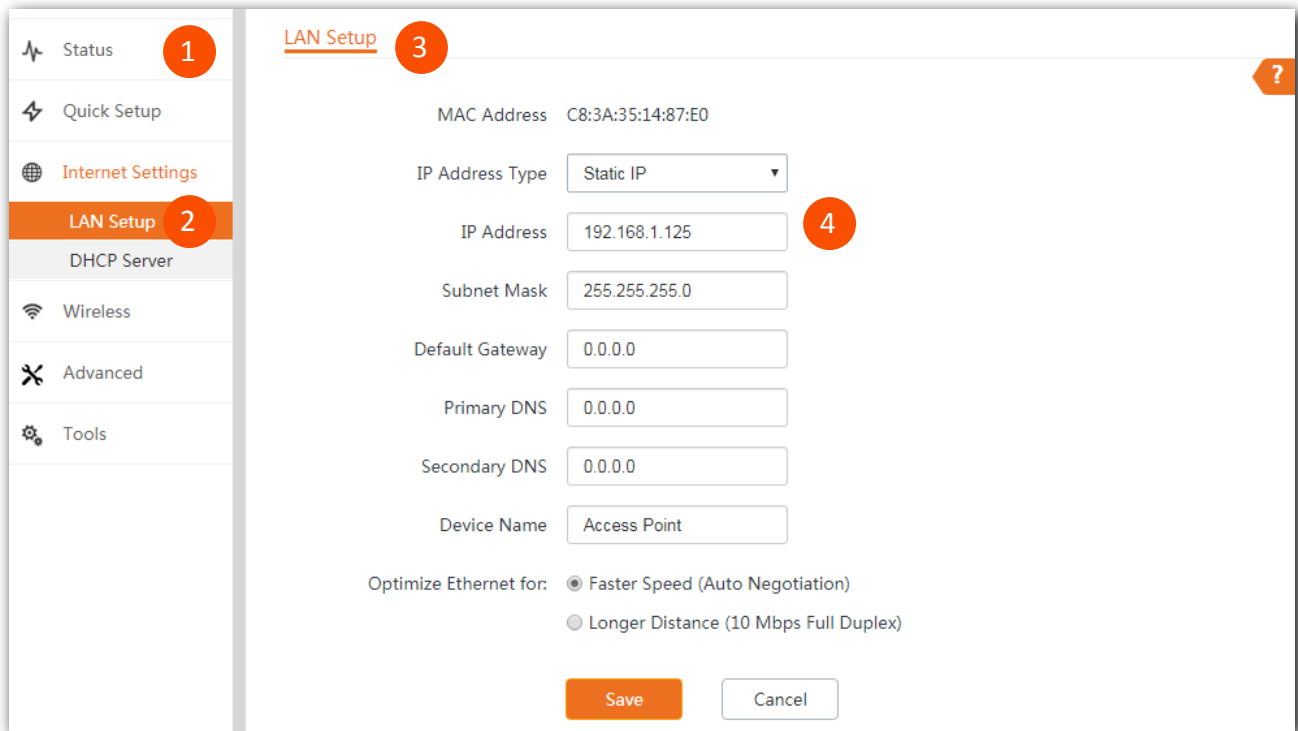

No.	Name	Description
1	Level-1 navigation bar	Used to display the function menu of the AP. Users can select functions in the navigation bars and the configuration appears in the configuration area.
2	Level-2 navigation bar	
3	Tab page area	
4	Configuration area	Used to modify or view your configuration.





TIP

The functions and parameters dimmed on the web UI indicate that they cannot be changed in the current configuration or they are not supported by the AP. To configure such functions or parameters, configure their related functions or parameters first.

1.4 Frequently-used buttons

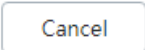
The following table describes the frequently-used buttons available on the web UI of the AP.

Button	Description
 Save	Used to save the configuration on the current page and enable the configuration to take effect.
 Cancel	Used to modify the current configuration on the current page back to the original configuration.
 ?	Used to get the online help.

2 Status

This module presents you with an overall running status of the AP, including system status, LAN port status, wireless status (2.4 GHz and 5 GHz), traffic statistics, and information of wireless clients connected to the AP. You are allowed to view rather than modifying here.

2.1 System status

This page displays the [System Status](#) and [LAN Port Status](#) of the AP.

To access the page, choose **Status > System Status**.

■ System Status

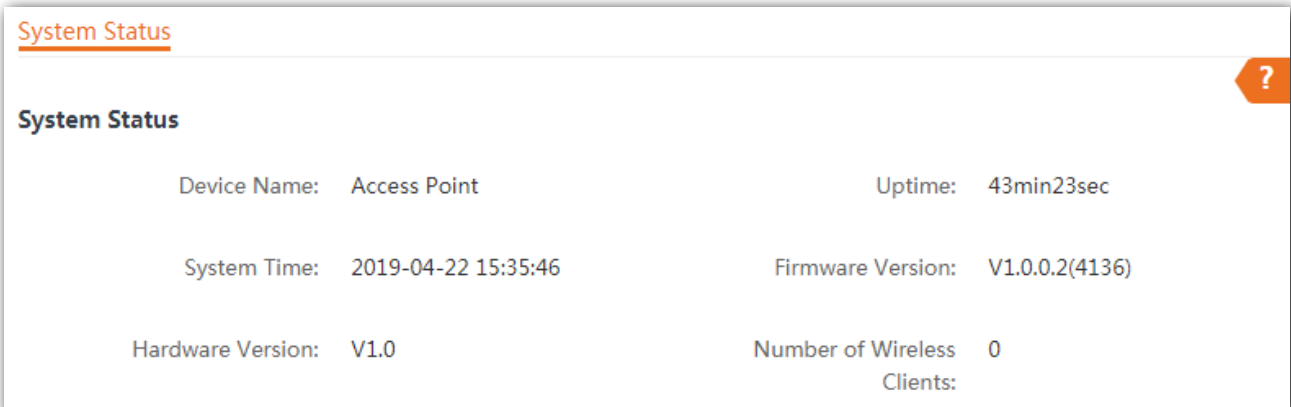

The screenshot shows the 'System Status' page with a help icon (question mark) in the top right corner. The page displays the following information:

Device Name:	Access Point	Uptime:	43min23sec
System Time:	2019-04-22 15:35:46	Firmware Version:	V1.0.0.2(4136)
Hardware Version:	V1.0	Number of Wireless Clients:	0

Parameter description

Parameter	Description
Device Name	It specifies the name of the AP. You can modify it on Internet Settings > LAN Setup page.
Uptime	It specifies the time that has elapsed since the AP starts up last time.
System Time	It specifies the current system time of the AP.  TIP To make time-related configurations work properly, ensure that the system time is correct. You can modify it on Tools > Date & Time page.
Firmware Version	It specifies the current firmware version number of the AP.
Hardware Version	It specifies the current hardware version number of the AP.

Parameter	Description
Number of Wireless Client	It specifies the quantity of wireless devices currently connected to the AP.

■ LAN Port Status

LAN Port Status:	
MAC Address:	C8:3A:35:D7:07:30
IP Address:	192.168.1.161
Subnet Mask:	255.255.255.0
Primary DNS:	0.0.0.0
Secondary DNS:	0.0.0.0

Parameter description

Parameter	Description
MAC Address	<p>It specifies the physical address of the AP's LAN port.</p> <p>If you connect the AP to other devices using Ethernet cables, the AP uses this MAC address to communicate with those devices.</p>
IP Address	<p>It specifies the IP address of the AP's LAN port, which can be used to log in to the web UI.</p> <p>You can modify it on Internet Settings > LAN Setup page.</p>
Subnet Mask	It specifies the subnet mask of the AP.
Primary DNS Server	It specifies the primary DNS server of the AP.
Secondary DNS Server	It specifies the secondary DNS server of the AP.

2.2 Wireless status

This page displays radio information and SSID information of the AP. You can get a glance of whether or not the radio frequency (RF) function is enabled, the network mode it currently uses, and the channel it operates, as well as all the SSIDs-related information. This page includes [RF status](#) and [SSID status](#).

To access the page, choose **Status > Wireless Status**.

■ RF status

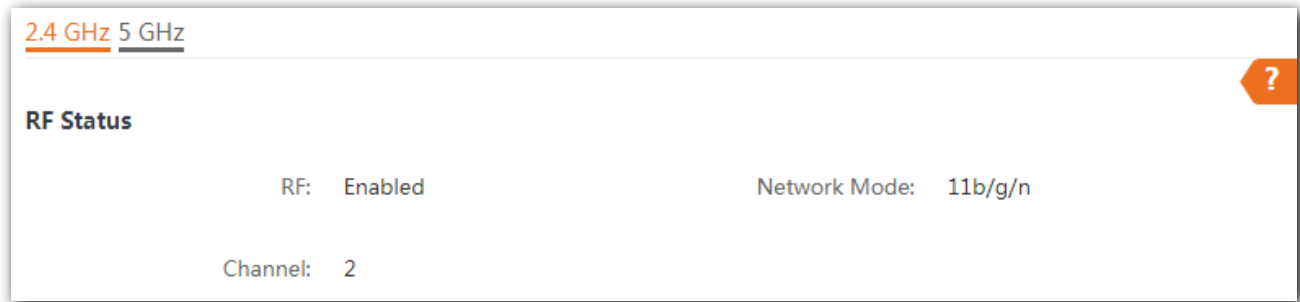

Parameter description

Parameter	Description
RF	<p>It specifies whether the WiFi network at the corresponding band is enabled.</p> <ul style="list-style-type: none">• Enabled: WiFi network at the corresponding band is enabled.• Disabled: WiFi network at the corresponding band is disabled.
Network Mode	<p>It specifies the network mode currently enabled by the AP on each radio band.</p>
Channel	<p>It specifies the current channel the AP operates on either 2.4 GHz or 5 GHz band.</p>

■ SSID status

SSID Status			
SSID	MAC Address	Status	Security Mode
Tenda_1487E0	C8:3A:35:14:87:E1	Enabled	None
Tenda_1487E1	C8:3A:35:14:87:E2	Disabled	None
Tenda_1487E2	C8:3A:35:14:87:E3	Disabled	None
Tenda_1487E3	C8:3A:35:14:87:E4	Disabled	None
Tenda_1487E4	C8:3A:35:14:87:E5	Disabled	None
Tenda_1487E5	C8:3A:35:14:87:E6	Disabled	None
Tenda_1487E6	C8:3A:35:14:87:E7	Disabled	None
Tenda_1487E7	C8:3A:35:14:87:E8	Disabled	None

Parameter description

Parameter	Description
SSID	<p>Wireless network name of the AP. The AP supports up to 8 SSIDs on 2.4 GHz and 4 SSIDs on 5 GHz.</p> <p> TIP</p> <p>The 1st SSID on the list indicates the primary SSID. By default, only the primary SSID on each radio band is enabled.</p>
MAC Address	It specifies the physical address of the corresponding wireless network.
Status	It specifies whether or not the corresponding WiFi network is enabled.
Security Mode	It specifies the security mode adopted by the corresponding WiFi network.

2.3 Traffic statistics

This page allows you to view statistical information about traffic based on SSIDs.

To access the page, choose **Status > Traffic Statistics**.

2.4 GHz 5 GHz

SSID	Received Traffic	Received Packets (Qty.)	Transmitted Traffic	Transmitted Packets (Qty.)
Tenda_1487E0	0.00MB	0	0.00MB	0
Tenda_1487E1	0.00MB	0	0.00MB	0
Tenda_1487E2	0.00MB	0	0.00MB	0
Tenda_1487E3	0.00MB	0	0.00MB	0
Tenda_1487E4	0.00MB	0	0.00MB	0
Tenda_1487E5	0.00MB	0	0.00MB	0
Tenda_1487E6	0.00MB	0	0.00MB	0
Tenda_1487E7	0.00MB	0	0.00MB	0

2.4 Client list

This page allows you to view wireless clients connected to each SSID of the AP and their basic information, and to block unknown wireless clients. Here, “client” refers to the devices connected to the AP’s wireless networks.

To access the page, choose **Status > Client List**.

The screenshot shows a web interface for viewing wireless clients. At the top, there are tabs for '2.4 GHz' and '5 GHz'. Below that, it says 'Clients connected to the SSID:' followed by a dropdown menu for 'SSID' currently set to 'Tenda_1487E0'. A table with the following columns is shown: ID, MAC Address, IP Address, Client Type, Connection Duration, Transmit Rate, Receive Rate, and Block. The table is empty, with 'No data' centered in the middle. At the bottom left, there is a pagination control showing '10' in a dropdown, 'in total/Page', and '0 in total'.

Parameter description

Parameter	Description
SSID	Select the SSID from the drop-down list menu to view client information connected to it.
MAC Address	It specifies the physical address of the client.
IP Address	It specifies the IP address of the client.
Client Type	<p>It specifies the operating system of the client.</p> <p> TIP</p> <p>The AP identifies the client type on two conditions:</p> <ul style="list-style-type: none">• The Identity Client Type function is enabled (To enable it, navigate to Wireless > Advanced Settings).• The client connected to the AP has accessed an http:// website. <p>Otherwise, -- is displayed.</p>
Connection Duration	It specifies the online time of the client.
Transmit Rate	It specifies the real time traffic the client has transmitted.
Receive Rate	It specifies the real time traffic the client has received.

Parameter	Description
Block	Click  to block the client from accessing the AP's wireless network. To unblock a client, navigate to Wireless > Access Control .

3 Working mode

The AP supports **AP mode** (default mode) and **Client+AP mode**. This chapter introduces how to set the working mode of the AP.

3.1 AP mode (default mode)

3.1.1 Typical network topology

In this mode, the AP connects to the internet in a wired manner, and converts wired network into wireless network. See the following typical network topology.

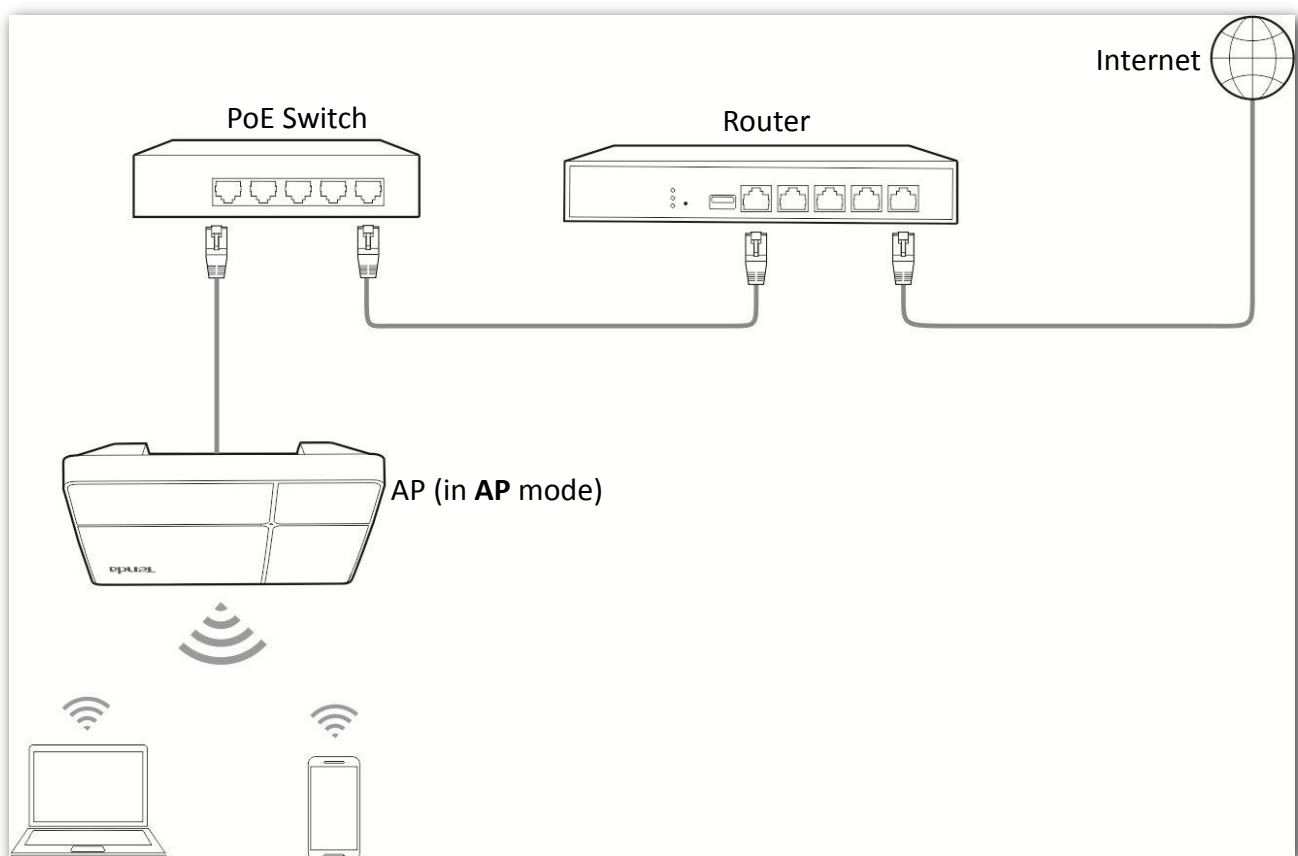

3.1.2 Getting familiar with AP mode configuration page

To access the configuration page, choose **Quick Setup**.

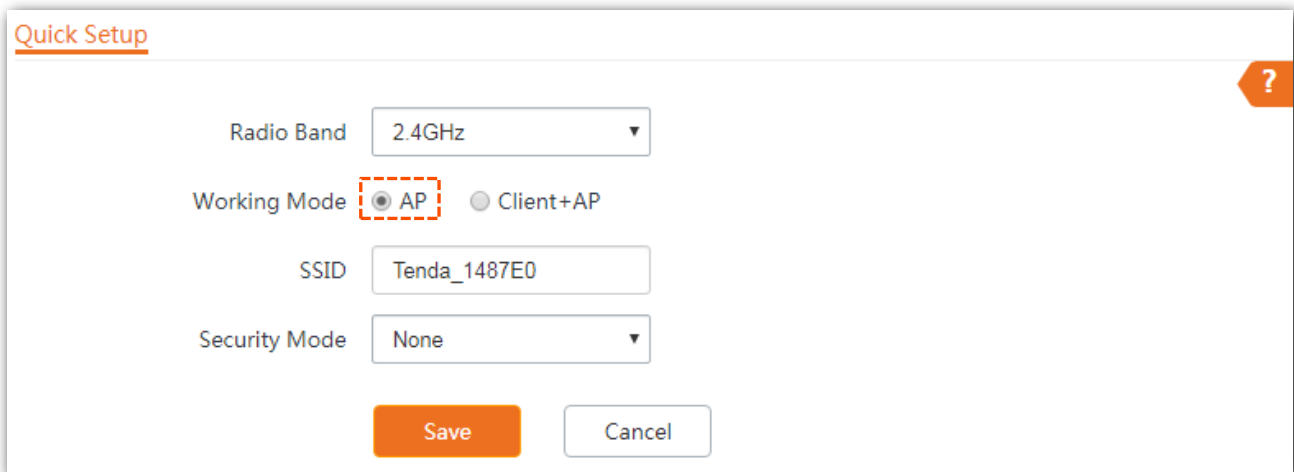

The screenshot shows the 'Quick Setup' configuration page. It includes a title bar with a question mark icon. The configuration fields are: Radio Band (2.4GHz), Working Mode (AP selected, Client+AP unselected), SSID (Tenda_1487E0), and Security Mode (None). There are 'Save' and 'Cancel' buttons at the bottom.

Parameter description

Parameter	Description
Radio Band	It is used to select the radio band for configurations.
Working Mode	It specifies the working modes supported by the device. <ul style="list-style-type: none">• AP mode (default mode): This mode is used to deploy wireless networks by connecting the AP to the internet in a wired manner.• Client+AP mode: This mode is used to extend the existing wireless network by bridging the upstream wireless signals.
SSID	Primary Wireless network name of the AP.  TIP The 1st SSID on each radio band indicates the primary SSID.
Security Mode	It specifies the security mode you set for your AP's WiFi network, including None , WEP , WPA-PSK , WPA2-PSK , Mixed WPA/WPA2-PSK , WPA and WPA2 . See Security Mode for details.

3.1.3 Configuring AP mode

Log in to the web UI of the AP, and choose **Quick Setup** to enter the configuration page first.



- By default, the device works in **AP** mode.
- The following introduces how to set the device into AP mode on 2.4 GHz band. Configuration on 5 GHz is identical.
- The device supports up to **8 SSIDs** on **2.4 GHz** band and **4 SSIDs** on **5 GHz** band. The SSID-related parameters on this page refer to the first (primary) SSID of the AP.

Before you start

Ensure that the upstream router has connected to the internet successfully.

Procedure

- Step 1** Select **2.4 GHz** from the **Radio Band** drop-down list menu.
- Step 2** Set **Working Mode** to **AP**.
- Step 3** Customize an **SSID** (wireless network name) in the **SSID** box, which is **Tenda_WiFi** in this example. This SSID is also your primary SSID on 2.4 GHz band.
- Step 4** Select the security mode from the **Security Mode** drop-down list menu, which is **WPA2-PSK** in this example.
- Step 5** Select the **Encryption Algorithm**, which is **AES** in this example.
- Step 6** Set a WiFi password in the **Key** box.
- Step 7** Click **Save** to apply your settings.

Quick Setup

Radio Band: 2.4GHz

Working Mode: AP Client+AP

SSID: Tenda_WiFi

Security Mode: WPA2-PSK

Encryption Algorithm: AES TKIP TKIP&AES

Key:

Save Cancel

---- End

After configuration, you can connect wireless devices to the WiFi network of your AP using the SSID and WiFi password you set.

3.2 Client+AP mode

3.2.1 Typical network topology

In this mode, the AP extends the existing wireless network by bridging the upstream wireless signals. See the following typical network topology.

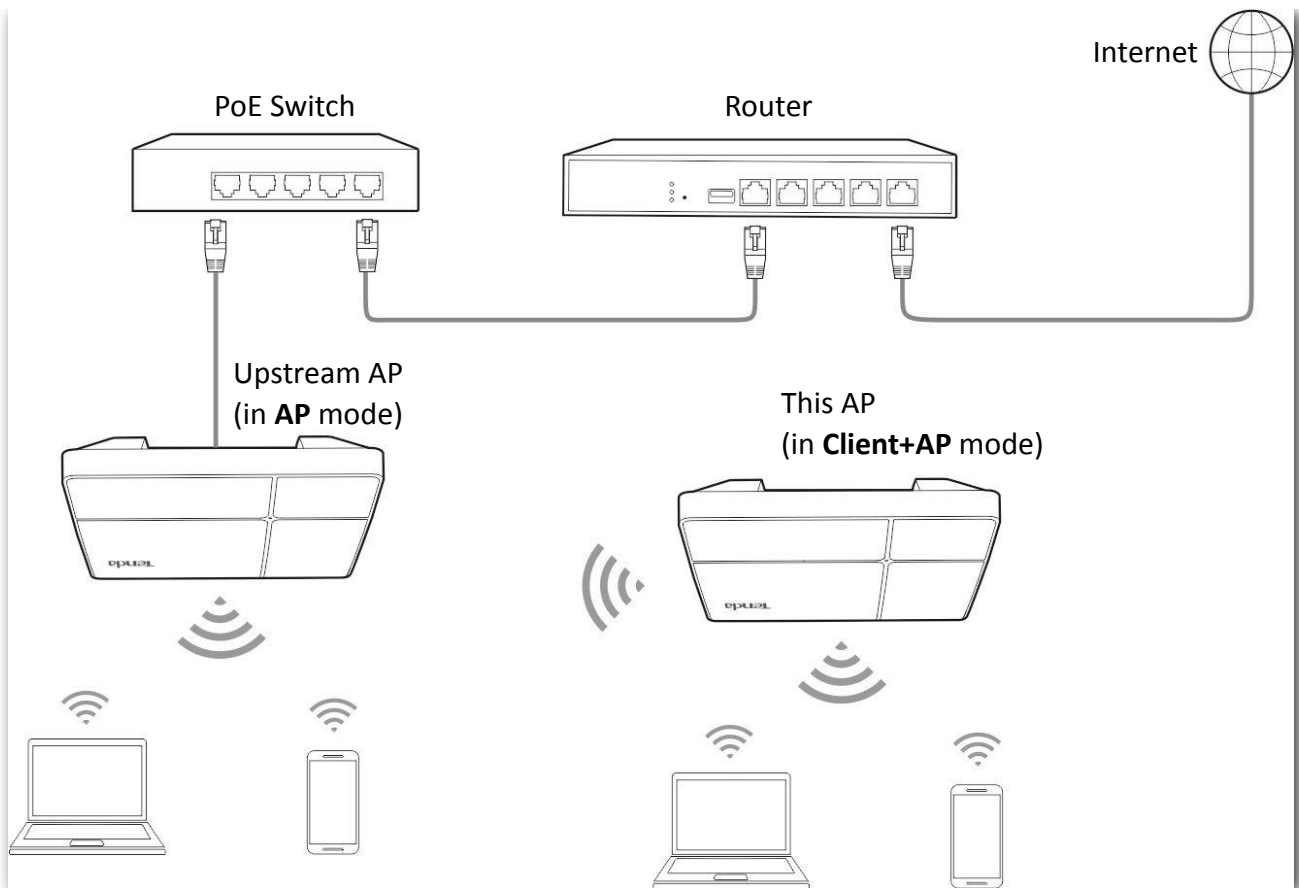

3.2.2 Getting familiar with Client+AP mode configuration page

To enter the configuration page, set **Working Mode** to **Client+AP**. See the following figure.

The screenshot shows the 'Quick Setup' configuration page. At the top left is the title 'Quick Setup' and at the top right is a question mark icon. The configuration options are as follows:

- Radio Band:** A dropdown menu set to '2.4GHz'.
- Working Mode:** Two radio buttons: 'AP' (unselected) and 'Client+AP' (selected and highlighted with a red dashed box).
- SSID:** An empty text input field.
- Security Mode:** A dropdown menu set to 'WPA2-PSK'.
- Encryption Algorithm:** Three radio buttons: 'AES' (selected), 'TKIP' (unselected), and 'TKIP&AES' (unselected).
- Key:** A text input field containing seven asterisks.
- Buttons:** 'Refresh' and 'Scan' buttons are positioned below the key field. 'Save' (orange) and 'Cancel' (white) buttons are at the bottom.

Parameter description

Parameter	Description
Radio Band	It is used to select the radio band for configurations.
Working Mode	<p>It specifies the working modes supported by the device.</p> <ul style="list-style-type: none">• AP mode (default mode): This mode is used to deploy wireless networks by connecting the AP to the internet in a wired manner.• Client+AP mode: This mode is used to extend the existing wireless network by bridging the upstream wireless signals.
SSID	It specifies the wireless network name of the upstream wireless network you selected.
Security Mode	It specifies the security mode adopted by the upstream wireless network you selected. See Security Mode for details.
Key	It specifies the WiFi password for the upstream wireless network you selected.
Refresh	Used to refresh the scan results.
Scan/Disable	<ul style="list-style-type: none">• Scan: Used to scan nearby available wireless networks. The scan results are displayed on the lower page.• Disable: The button only appears after you clicked Scan. It is used to end the scan operation and collapse the scan result.

3.2.3 Configuring Client+AP mode

Log in to the web UI of the AP, and choose **Quick Setup** to enter the configuration page first.



- By default, the device works in **AP** mode.
- The following introduces how to set the device into **Client+AP** mode on 2.4 GHz band. Configuration on 5 GHz is identical.
- This device does not support dual-band bridging in Client+AP mode. Enabling Client+AP mode on 2.4 GHz band clears Client+AP configuration (if any) on 5 GHz band. And vice versa.

Procedure

Step 1 Select **2.4 GHz** from the **Radio Band** drop-down list menu.

Step 2 Set **Working Mode** to **Client+AP**.

Step 3 Click **Scan**. The nearby available radio signals appear on the lower page.



If the SSID for bridging is not displayed, check if your upstream wireless network is enabled. If not, enable it. Then refresh the scan result.

Step 4 Select the WiFi network to bridge, which is **Tenda_Router** in this example.

The device detects and auto-fills **SSID**, **Security Mode**, **Encryption**, and **Algorithm** of the upstream wireless network for you, except the **Key**, which requires you to enter manually.

Step 5 Click **Save** to apply your settings.

Quick Setup ?

Radio Band: 2.4GHz

Working Mode: AP Client+AP

SSID: Tenda_Router

Security Mode: WPA-PSK & WPA2-PSK

Encryption Algorithm: AES TKIP TKIP&AES

Key:

Click to refresh scan result. ←
 → Click to collapse scan result

Scan result

Select	SSID	MAC Address	Channel Bandwidth	Channel	Security Mode	Signal Strength
<input checked="" type="radio"/>	Tenda_Router	D8:32:14:4C:CB:71	20MHz	1	Mixed WPA/WPA2-PSK...	

---- End

After the configuration, devices connected to the AP can access the upstream wireless network.

4 Internet settings

4.1 LAN setup

4.1.1 Overview

This section introduces how to:

- Modify the IP address obtaining method of the AP.
- Modify device name.
- Modify negotiation mode.

To access the configuration page, choose **Internet Settings > LAN Setup**.

LAN Setup

MAC Address C8:3A:35:14:87:E0

IP Address Type Static IP

IP Address 192.168.0.254

Subnet Mask 255.255.255.0

Default Gateway 0.0.0.0

Primary DNS 0.0.0.0

Secondary DNS 0.0.0.0



Device Name Access Point

Optimize Ethernet for:

- Faster Speed (Auto Negotiation)
- Longer Distance (10 Mbps Full Duplex)

Save Cancel

Parameter description

Parameter	Description
MAC Address	It specifies the MAC address of the AP's LAN port.
IP Address Type	<p>It specifies IP address obtaining method of the AP.</p> <ul style="list-style-type: none">• Static IP (default): You are required to set related parameters manually.• DHCP (Dynamic IP Address): The AP automatically obtains related parameters from a DHCP server on your LAN network.
IP Address	It specifies the LAN IP address (also the login IP address) of the AP. Default: 192.168.0.254 .
Subnet Mask	It specifies the subnet mask of the AP. Default: 255.255.255.0 .
Default Gateway	<p>It specifies the gateway IP address of the AP.</p> <p>Generally, enter the LAN IP address of the router which has internet accessibility into this box.</p>
Primary DNS	<p>It specifies the IP address of the primary DNS server of the AP.</p> <p>If DNS proxy function is supported on your router connected to the internet, you can set the IP address of the primary DNS server to the LAN IP address of your router. Otherwise, enter a correct DNS server IP address.</p>
Secondary DNS	It specifies the IP address of the secondary DNS server of the AP. This parameter is optional.
Device Name	<p>It specifies the name of the AP.</p> <p> TIP</p> <p>For later convenient management, you are recommended to modify each AP's name.</p>
Optimize Ethernet for	<ul style="list-style-type: none">• Faster Speed (Auto Negotiation): This option features a high data rate but short transmission distance. Generally, we recommend you select this option.• Longer Distance (10 Mbps Half Duplex): This option features long transmission distance but low data rate. Generally, the negotiated speed is 10 Mbps. <p> TIP</p> <p>If the Ethernet cable connecting the Ethernet port of the AP to the peer device is longer than 100 meters, the Longer Distance mode is recommended. In this case, ensure that the peer device adopts auto negotiation option.</p>

4.1.2 Configuring the AP to obtain IP address automatically (for multiple APs)

To access the configuration page, choose **Internet Settings > LAN Setup** first.

Procedure

Step 1 Select **DHCP (Dynamic IP Address)** from the **IP Address Type** drop-down list menu.

The IP address-related parameters dimmed and cannot be configured.

Step 2 Click **Save** to apply your settings.

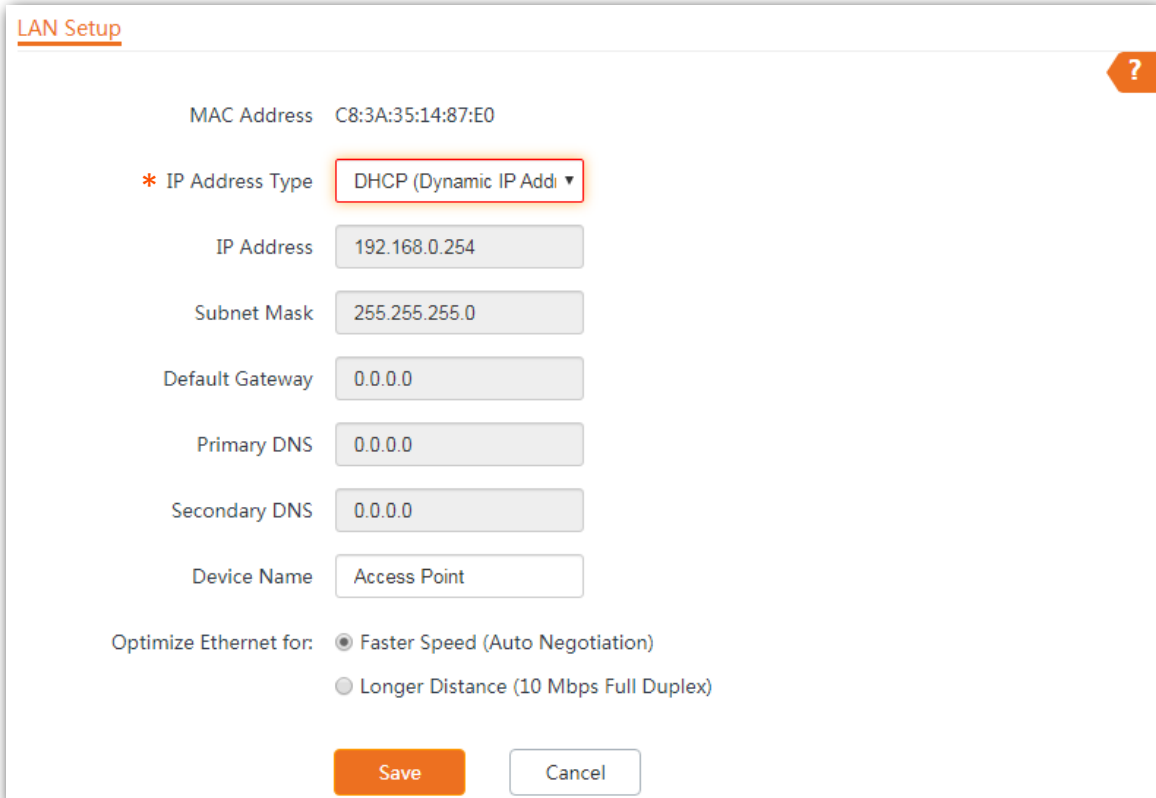

LAN Setup

MAC Address C8:3A:35:14:87:E0

* IP Address Type DHCP (Dynamic IP Add ▾)

IP Address 192.168.0.254

Subnet Mask 255.255.255.0

Default Gateway 0.0.0.0

Primary DNS 0.0.0.0

Secondary DNS 0.0.0.0

Device Name Access Point

Optimize Ethernet for:

Faster Speed (Auto Negotiation)

Longer Distance (10 Mbps Full Duplex)

Save Cancel

---- End

To view the new IP address assigned to the AP, go to the upstream DHCP client list.

4.1.3 Configuring the AP to use static IP address (for few APs)

To access the configuration page, choose **Internet Settings** > **LAN Setup** first.

Procedure

Step 1 Select **Static IP** from the **IP Address Type** drop-down list menu.

The IP address-related parameters become configurable.

Step 2 Customize required parameters.

Step 3 Click **Save** to apply your settings.

LAN Setup

MAC Address C8:3A:35:14:87:E0

* IP Address Type Static IP

* IP Address 192.168.0.254

* Subnet Mask 255.255.255.0

* Default Gateway 0.0.0.0

* Primary DNS 0.0.0.0

Secondary DNS 0.0.0.0

Device Name Access Point

Optimize Ethernet for: Faster Speed (Auto Negotiation)
 Longer Distance (10 Mbps Full Duplex)

Save Cancel

---- End

After the configuration, if the new IP address of the AP belongs to the same network segment as the IP address of your management computer, you can log in to the web UI of the AP directly using the new IP address. Otherwise, before logging in to the AP's web UI using the new IP address, assign your computer an IP address that belongs to the same network segment as the new IP address.

4.2 DHCP server

4.2.1 Overview

The AP supports the DHCP server function to assign IP addresses to devices connected to it. By default, this function is disabled. After this function enabled, the following page appears.



If another DHCP server is available in your LAN, ensure that the IP address pool of the AP does not overlap the IP address pool of that DHCP server. Otherwise, IP address conflicts may occur.

DHCP Server **DHCP Clients**

DHCP Server

Start IP Address

End IP Address

Subnet Mask

Gateway Address



Primary DNS

Secondary DNS

Lease Time

Parameter description

Parameter	Description
DHCP Server	It specifies whether or not to enable the DHCP server function of the AP.
Start IP Address	It specifies the start IP address of the DHCP server's IP address pool. The default value is 192.168.0.100 .
End IP Address	It specifies the end IP address of the DHCP server's IP address pool. The default value is 192.168.0.200 .  The End IP address must be greater than the Start IP address .

Parameter	Description
Subnet Mask	It specifies the subnet mask assigned by the DHCP server to devices. The default value is 255.255.255.0 .
Gateway Address	<p>It specifies the gateway IP address assigned by the DHCP server to devices. Generally, it is the LAN IP address of the router connected to the internet. The default value is 192.168.0.1.</p> <p> TIP</p> <p>Only through a gateway can a LAN device access a server or host which is not in the local network segment. You are recommended to enter a gateway IP address which can access the internet. Otherwise, the device in the LAN network cannot access the internet.</p>
Primary DNS	<p>It specifies the DNS server address provided by your ISP. If you do not know it, please consult your ISP.</p> <p> TIP</p> <p>To enable devices to access the internet, set this parameter to a correct DNS server IP address or DNS proxy IP address.</p>
Secondary DNS	It specifies the second DNS server address (if any) provided by your ISP. This parameter is optional, which indicates you can leave it blank if your ISP does not provide this parameter.
Lease Time	<p>It specifies the validity period of an IP address assigned by the DHCP server to a device. By default, it is 1 day.</p> <p>When half of the lease time has elapsed, the device sends a DHCP request to the DHCP server to renew the lease time. If the request succeeds, the lease time is extended based on the request. Otherwise, the device sends a request again when 7/8 of the lease time has elapsed. If the request succeeds, the lease time is extended based on the request. Otherwise, the device must request a new IP address from the DHCP server after the lease time expires.</p> <p>You are recommended to retain the default value.</p>

4.2.2 Configuring DHCP server of the AP

To access the configuration page, choose **Internet Settings > DHCP Server**.

Procedure

Step 1 Enable **DHCP Server** function.

Step 2 Customize required parameters.



- The **End IP Address** must be greater than the **Start IP Address**.
- The **Start IP Address**, **End IP Address**, and **Gateway Address** must belong to the same network segment as that of the LAN IP of the device.

Step 3 Click **Save** to apply your settings.

DHCP Server **DHCP Clients**

DHCP Server

Start IP Address

End IP Address

Subnet Mask

Gateway Address

Primary DNS

Secondary DNS

Lease Time

Save

---- End

4.2.3 Viewing DHCP clients

To view DHCP clients and their connection information, choose **Internet Settings > DHCP Server**, and click the **DHCP Clients** tab. See the following figure.

DHCP Server **DHCP Clients**

DHCP client list

ID	Host Name	IP Address	MAC Address	Lease Time
1	Honor_9-2b0d9d81e4...	192.168.1.147	54:B1:21:56:62:45	23hrs 59min 31sec

10 in total/Page 1 in total

5 Wireless

5.1 SSID

5.1.1 Overview

This module enables you to set SSID-related parameters of the AP.

To access the configuration page, choose **Wireless > SSID**.

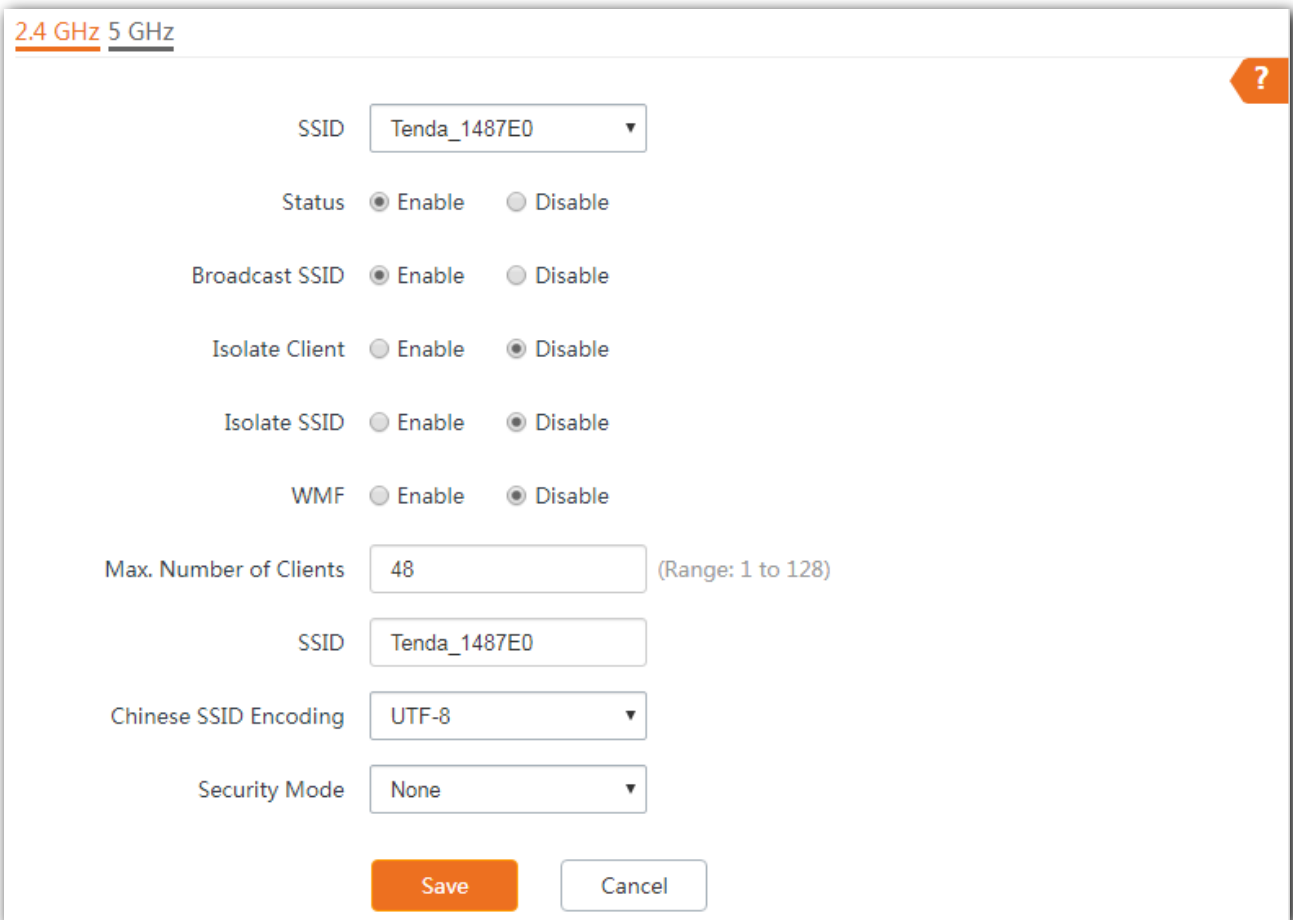

2.4 GHz 5 GHz

SSID

Status Enable Disable

Broadcast SSID Enable Disable

Isolate Client Enable Disable

Isolate SSID Enable Disable

WMF Enable Disable



Max. Number of Clients (Range: 1 to 128)

SSID

Chinese SSID Encoding

Security Mode

Parameter description

Parameter	Description
SSID	<p>Select one SSID from the drop-down list menu.</p> <p> TIP</p> <p>The AP allows you to enable 8 SSIDs on 2.4 GHz band, and 4 SSIDs on 5 GHz band.</p>
Enable	Used to enable or disable the wireless network you selected.
Broadcast SSID	<ul style="list-style-type: none"> • Enable: Nearby wireless clients can detect the SSID. • Disable: Nearby wireless clients cannot detect the SSID, and you need to enter the SSID manually on the wireless client to access the wireless network.
Isolate Client	<p>This parameter implements a function similar to the VLAN function for wired networks. It isolates the wireless devices connected to the same WiFi network, so that the wireless devices can access only the wired network connected to the AP. You can apply this function to hotspot setup in public spaces, such as hotels and airports to improve network security.</p>
WMF	<p>The number of wireless devices keeps increasing currently, but wired and wireless bandwidth resources are limited. Therefore, the multicast technology, which enables single-point data transmission and multi-point data reception, has been widely used in networks in order to reduce bandwidth requirements and prevent network congestion.</p> <p>Nevertheless, if a large number of devices are connected to a wireless interface of a WiFi network and multicast data is intended for only one of the devices, the data is still sent to all the devices, which increases unnecessary wireless resource usage and may lead to wireless channel congestion. In addition, multicast stream forwarding over an 802.11 network is not secure, either.</p> <p>The WMF function of the AP converts multicast traffic into unicast traffic and forwards the traffic to the multicast traffic destination in the WiFi network, helping save wireless resources, ensuring reliable transmission, and reducing delays.</p>
Suppress Broadcast Probe Response	If enabled, this device does not respond to the requests without an SSID, saving wireless resources.
Max. Number of Clients	<p>This parameter specifies the maximum number of devices that can connect to the WiFi network corresponding to an SSID. If the number is reached, the WiFi network rejects new connection requests from devices. This limit helps balance load among SSIDs.</p> <p> TIP</p> <p>The AP supports 128 clients at most. That is to say, clients connected to all the enabled wireless networks of the AP cannot exceed 128. If you enable multiple SSIDs, plan your maximum number of clients to each SSID first.</p>
Chinese SSID Encoding	<p>It specifies the character encoding format.</p> <p>Available options include GB2312 and UTF-8.</p> <p> TIP</p> <p>A proper encoding format lets the SSID containing Chinese characters be displayed</p>

Parameter	Description
	normally across devices.
Security Mode	<p>It specifies the security modes supported by the AP, including:</p> <ul style="list-style-type: none"> • None: This wireless network is open. The security level is the lowest. • WEP: Wired Equivalent Privacy. The security level is very low. • WPA-PSK, WPA2-PSK, and Mixed WPA/WPA2-PSK: Applicable to most scenarios. • WPA and WPA2: This mode provides highest security level. It use 802.1 x RADUIS to encrypt and is applicable to enterprises. <p> TIP</p> <p>See Security Mode for details.</p>

Security Mode

A WiFi network uses radio open to the public as its data transmission medium. If the WiFi network is not protected by necessary measures, any device can connect to the network to access unprotected data over the network or the resources of the network. To ensure communication security, transmission links of WiFi network must be encrypted.

The AP supports various security modes for network encryption, including **None**, **WEP**, **WPA-PSK**, **WPA2-PSK**, **Mixed WPA/WPA2-PSK**, and **WPA/WPA2**.

■ None

It indicates that any wireless device can connect to the WiFi network. This option is not recommended because it leads to network insecurity.

■ WEP

It uses a static key to encrypt all exchanged data, and ensures that a WLAN has the same level of security as a wired LAN. However, data encrypted based on WEP can be easily cracked. In addition, WEP supports a maximum WiFi network throughput of only 54 Mbps. Therefore, this security mode is not recommended.

Select **WEP** from the **Security Mode** drop-down list menu, the following parameters appear. See the following figure.

The screenshot shows a configuration window for WEP security. The 'Security Mode' is set to 'WEP'. The 'Authentication Type' is set to 'Open'. The 'Default Key' is set to 'Key 1'. There are four key input fields, each with an 'ASCII' dropdown menu. The 'Save' button is orange, and the 'Cancel' button is white with a grey border.

Parameter description

Parameter	Description
Authentication Type	<p>WEP consists of two authentication types.</p> <ul style="list-style-type: none"> • Open: In this authentication, the wireless client does not need to provide the credentials to the access point while authenticating. Generally, this authentication is recommended when privacy is the main concern. • Shared: This authentication requires four step challenge-response handshake to accomplish authentication. It is less secure than WEP Open since during authentication process, WEP key is exposed.
Default Key	It indicates the designated key used for wireless clients to connect to the access point.
Key1/2/3/4	Enter one to four WEP keys, each of which consists of 5 or 13 ASCII printable characters or 10 or 26 hexadecimal characters. Only the key that is designated as the Default Key is effective.

■ WPA-PSK, WPA2-PSK, and Mixed WPA/WPA2-PSK

They belong to pre-shared key or personal key modes, where Mixed WPA/WPA2-PSK supports both WPA-PSK and WPA2-PSK.

WPA-PSK, WPA2-PSK, and Mixed WPA/WPA2-PSK adopt a pre-shared key for authentication, while the AP generates another key for data encryption. This prevents the vulnerability caused by static WEP keys, and makes the three security modes suitable for ensuring security of home WiFi networks. Nevertheless, because the initial pre-shared key for authentication is manually set and all devices use the same key to connect to the same AP, the key may be disclosed unexpectedly. This makes the security modes not suitable for scenarios where high security is required.

Select **WPA-PSK** (or **WPA2-PSK**, or **Mixed WPA/WPA2-PSK**) from the **Security Mode** drop-down list menu, the following parameters appear. See the following figure.

Parameter description

Parameter	Description
Encryption Algorithm	<p>The AP supports the following three encryption algorithms:</p> <ul style="list-style-type: none"> • AES: Advanced Encryption Standard. This is newer Wi-Fi encryption solution used by the new-and-secure WPA2 standard. It is more secure than TKIP. • TKIP: Temporal Key Integrity Protocol. This is an older encryption protocol introduced with WPA. This option is recommended only when you have older devices that can't connect to a WPA2-PSK (AES) network. • AES&TKIP: It indicates that both AES and TKIP are supported.
Key	It indicates the key used for wireless clients to connect to the access point.
Key Update Interval	It indicates the interval at which a WPA key is updated. A shorter interval leads to higher security.

■ WPA and WPA2

To address the key management weakness of WPA-PSK and WPA2-PSK, the WiFi Alliance puts forward WPA and WPA2, which use 802.1x to authenticate devices and generate data encryption-oriented root keys. WPA and WPA2 use the root keys to replace the pre-shared keys that set manually, but adopt the same encryption process as WPA-PSK and WPA2-PSK.

WPA and WPA2 uses 802.1x to authenticate devices and the login information of a device is managed by the device. This effectively reduces the probability of information leakage. In addition, each time a device connects to an AP that adopts the WPA or WPA2 security mode, the RADIUS server generates a data encryption key and assigns it to the device, which makes it difficult for attackers to obtain the key. These features of WPA and WPA2 security modes help increase network security significantly, making WPA and WPA2 the preferred security modes of WiFi networks that require high security.

Select **WPA** (or **WAP2**) from the **Security Mode** drop-down list menu, the following parameters

appear. See the following figure.

Security Mode: WPA

RADIUS Server: [Empty]

RADIUS Port: 1812 (Range: 1025 to 65535. Default: 1812)

RADIUS Key: [Empty]

Encryption Algorithm: AES TKIP TKIP&AES

Key Update Interval: 0 Second (Range: 60 to 99999. 0 indicates no upgrade)

Buttons: Save, Cancel

Parameter description

Parameter	Description
RADIUS Server	Enter the IP address of RADIUS server.
RADIUS Port	Enter the authentication port number of the RADIUS sever.
RADIUS Key	Enter the password used for RADIUS authentication.

5.1.2 Modifying SSID-related parameters

To enter the configuration page, choose **Wireless > SSID** first.

Procedure



- The following takes configuration on 2.4 GHz band for example. Configuration on 5 GHz is identical.
- The following introduces how to modify parameters on this page. Modify them based on your actual requirements.

Step 1 Select the SSID from the **SSID** drop-down list menu.

Step 2 Set **Status** to **Enable**.

Step 3 (Optional) Enable **Broadcast SSID**, **Isolate Client**, **Isolate SSID**, **WMF**, and modify the number of client that can connect to this specific SSID in the **Max. Number of Clients** box.



- The AP supports **128** clients at most. That is to say, clients connected to all the enabled wireless networks of the AP cannot exceed 128. If you enable multiple SSIDs, plan your maximum number of clients to each SSID first.
- The AP allows you to enable **8 SSIDs** on **2.4 GHz** band, and **4 SSIDs** on **5 GHz**.

Step 4 (Optional) Customize SSID and security-related parameters as required.

- **SSID:** Modify the default one if necessary.
- **Chinese SSID Encoding:** A proper encoding format lets the SSID containing Chinese characters be displayed normally across devices.
- **Security Mode:** Choose a security mode and configure related parameters.

Step 5 Click **Save** to apply your settings.

2.4 GHz 5 GHz

SSID: Tenda_1487E0

Status: Enable Disable

Broadcast SSID: Enable Disable

Isolate Client: Enable Disable

Isolate SSID: Enable Disable

WMF: Enable Disable

Max. Number of Clients: 48 (Range: 1 to 128)

SSID: Tenda_01

Chinese SSID Encoding: UTF-8

Security Mode: WPA2-PSK

Encryption Algorithm: AES TKIP TKIP&AES

Key:

Key Update Interval: 0 Second (Range: 60 to 99999. 0 indicates no upgrade)

Save Cancel

---- End

5.1.3 Example of configuring a WiFi network encrypted by WPA or WPA2

■ Network topology

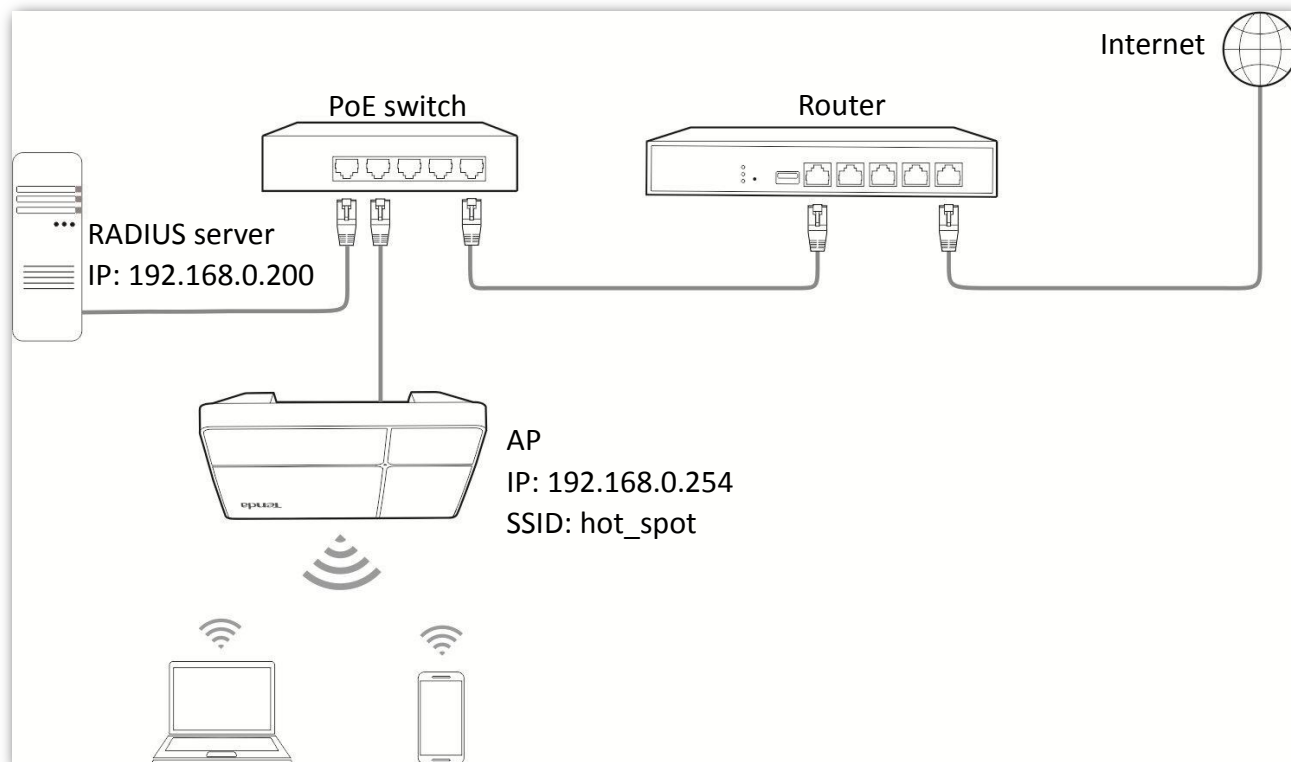

Configuration description

Configuring a WiFi network encrypted by WPA or WPA2 involves operations across various devices. This guide will walk you through the configuration step by step.

The following table summarizes the overall steps. Get yourself familiar with the whole process before you start.

Step	Task	Description
1	Configure the AP.	Select the SSID you want to implement the RADIUS authentication, and enable it. Modify the SSID as required. Then set the security mode to WPA2 and enter the RADISU server-related parameters.
2	Create RADIUS client.	Create a RADIUS client first, and then create a remote access policy.
3	Configure wireless network information on the wireless client.	Add the wireless network enabled with WPA or WPA2 of the AP manually, and configure its security settings.

Procedure

Step 1 Configure the AP.



In this case, we assume that you have installed and configured a RADIUS server in your company, and have obtained the following information:

- **RADIUS Server:** IP address or domain name of the RADIUS server, which is **192.168.0.200** in this example.
 - **RADIUS Port:** Port number used for authentication, which is **1812** in this example
 - **RADIUS Password:** Password used for authentication which is **12345678** in this example.
-

1. Select an SSID from the **SSID** drop-down list menu, and set the **Status** to **Enable**.
2. Modify the **SSID** to **hot_spot**.
3. Select **WPA2** from the **Security Mode** drop-down list menu. The RADIUS-related parameters appear.
4. Enter your **RADIUS Server**, **RADIUS Port**, and **RADIUS Password**. Parameters on the following figure are only for examples.
5. Set **Encryption Algorithm** to **AES**.
6. Click **Save** to apply your settings.

* SSID

* Status Enable Disable

Broadcast SSID Enable Disable

Isolate Client Enable Disable

Isolate SSID Enable Disable

WMF Enable Disable

Max. Number of Clients (Range: 1 to 128)

* SSID

Chinese SSID Encoding

* Security Mode

* RADIUS Server

* RADIUS Port (Range: 1025 to 65535. Default: 1812)

* RADIUS Key

* Encryption Algorithm AES TKIP TKIP&AES

Key Update Interval Second (Range: 60 to 99999. 0 indicates no upgrade)

Step 2 Configure RADIUS client (Example: Windows 2003)

1. Configure a RADIUS client.

(1) In the **Computer Management** dialog box, double-click **Internet Authentication Service**, right-click **RADIUS Clients**, and choose **New RADIUS Client**.

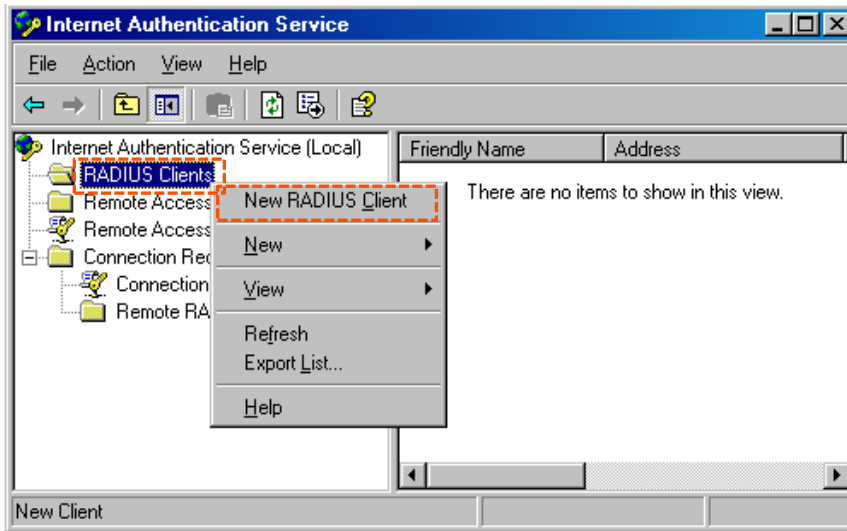

- (2) Enter a RADIUS client name (device name of the AP is recommended) and the IP address of the AP, and click **Next**.

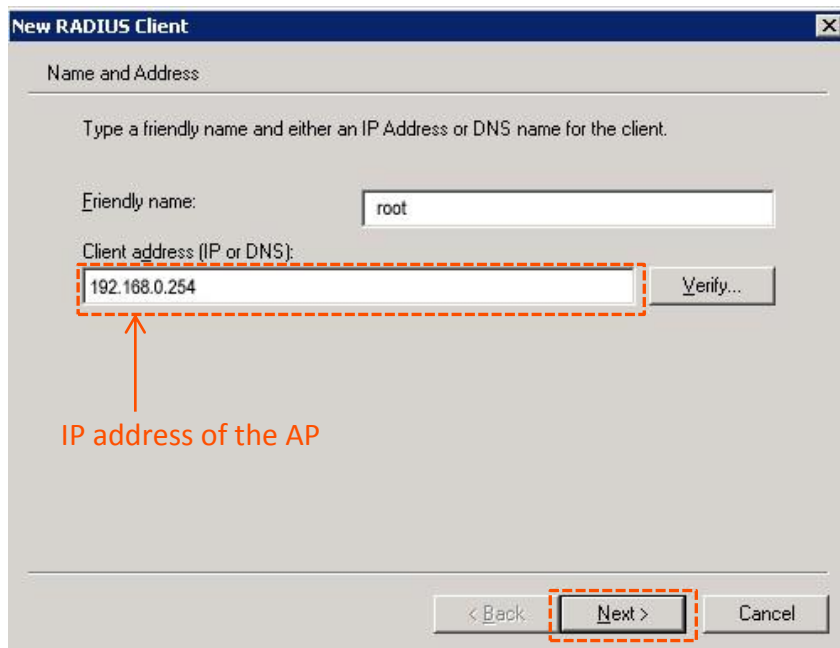

- (3) Enter **12345678** in the **Shared secret** and **Confirm shared secret** text boxes, and click **Finish**.

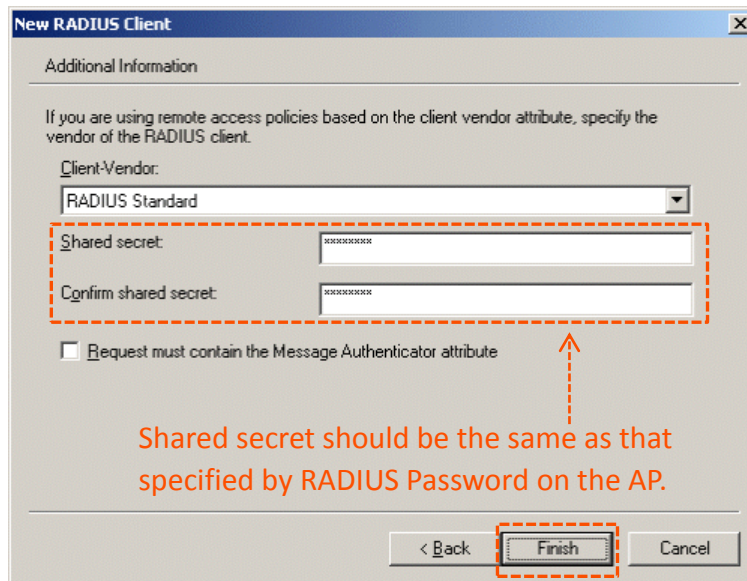

2. Configure a remote access policy.

- (1) Right-click **Remote Access Policies** and choose **New Remote Access Policy**.

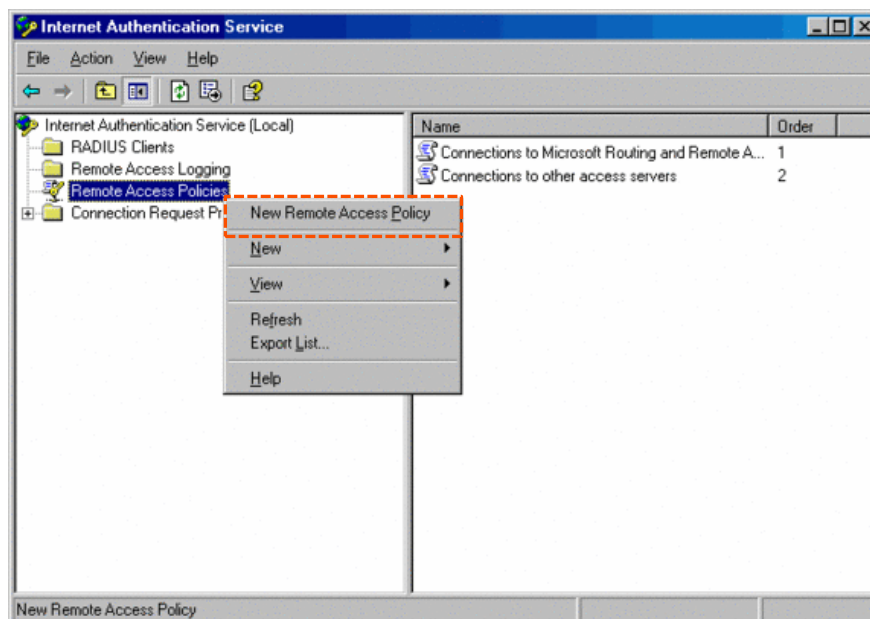

- (2) In the **New Remote Access Policy Wizard** dialog box that appears, click **Next**.

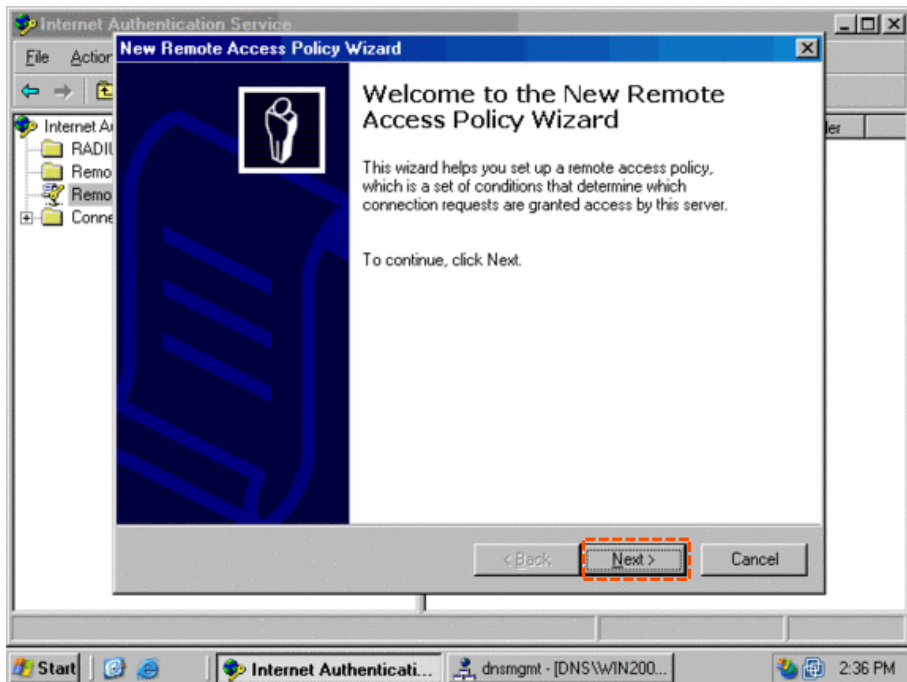

- (3) Enter a policy name and click **Next**.

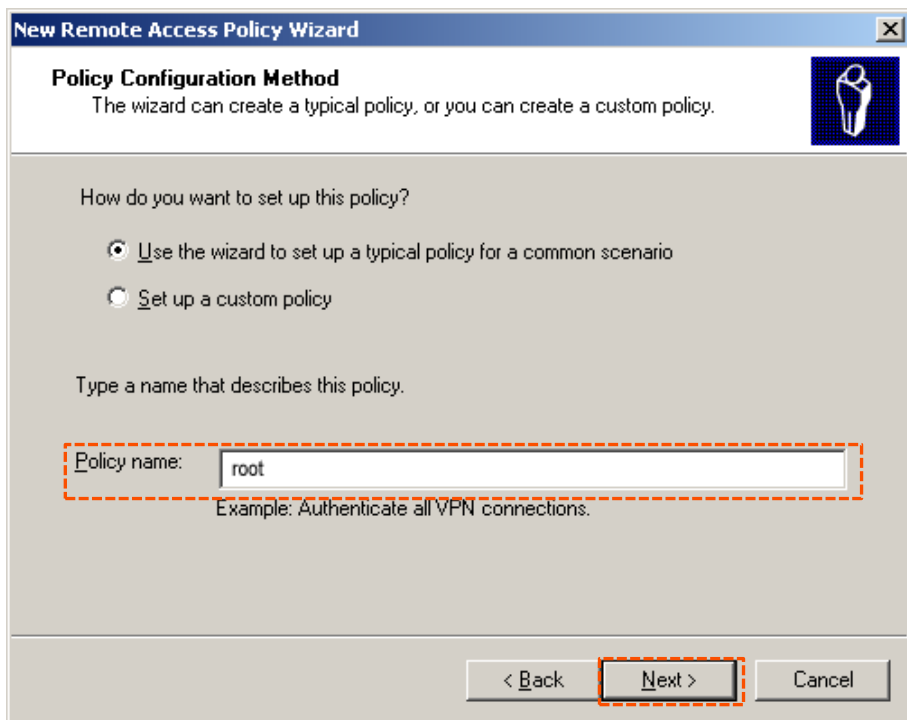

- (4) Select **Ethernet** and click **Next**.

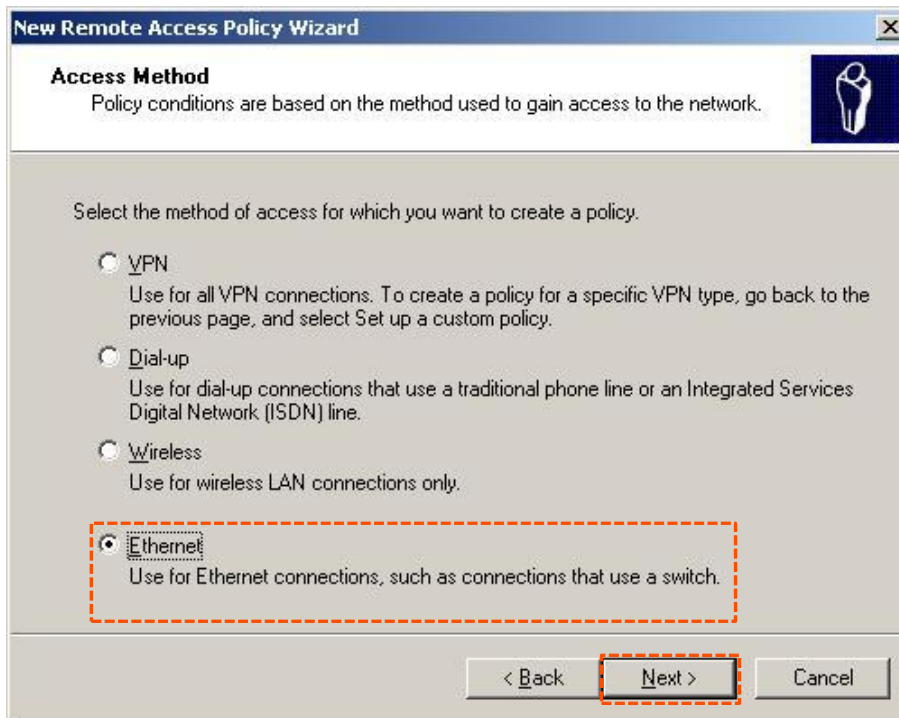

- (5) Select **Group** and click **Add**.

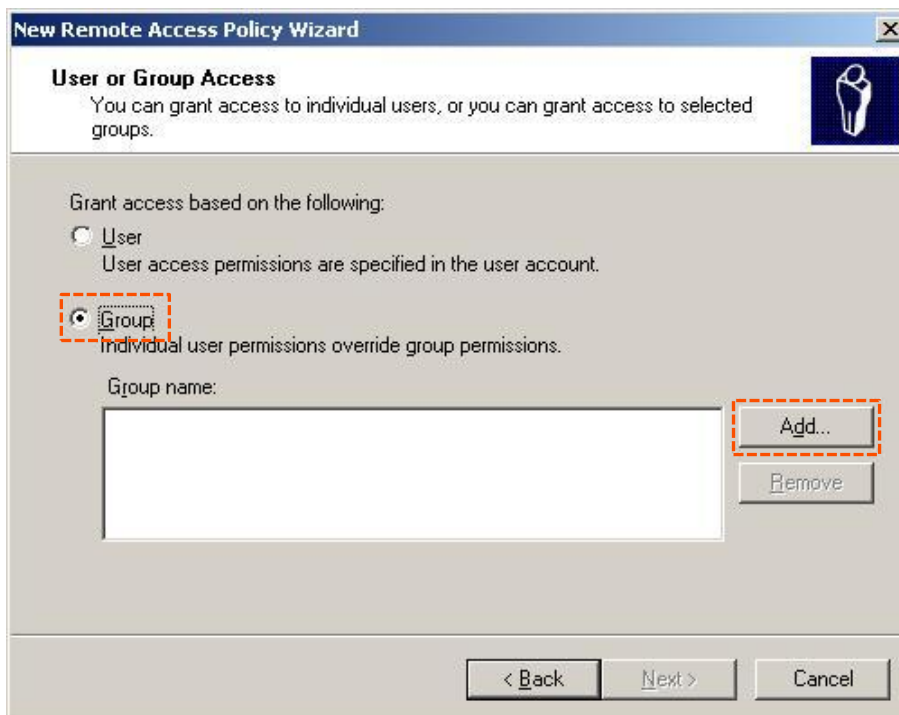

- (6) Enter **802.1x** in the Enter the object names to select text box, click **Check Names**, and click **OK**.

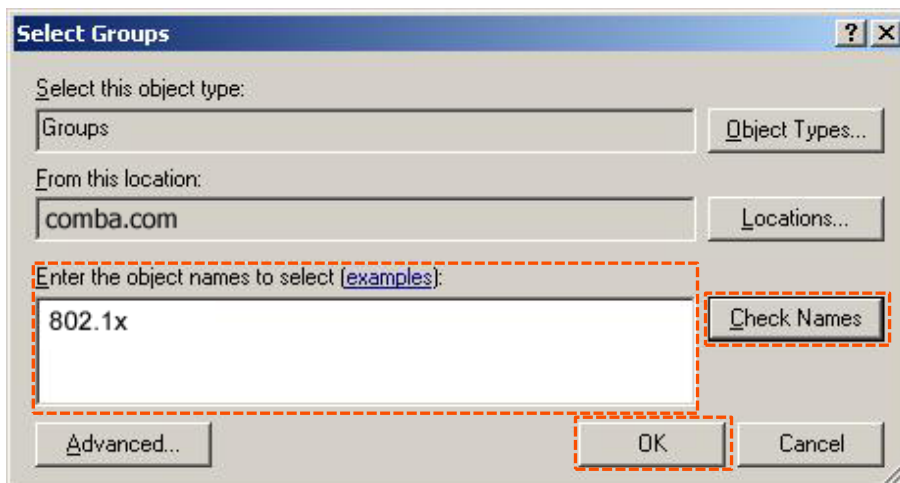

- (7) Select **Protected EAP (PEAP)** and click **Next**.

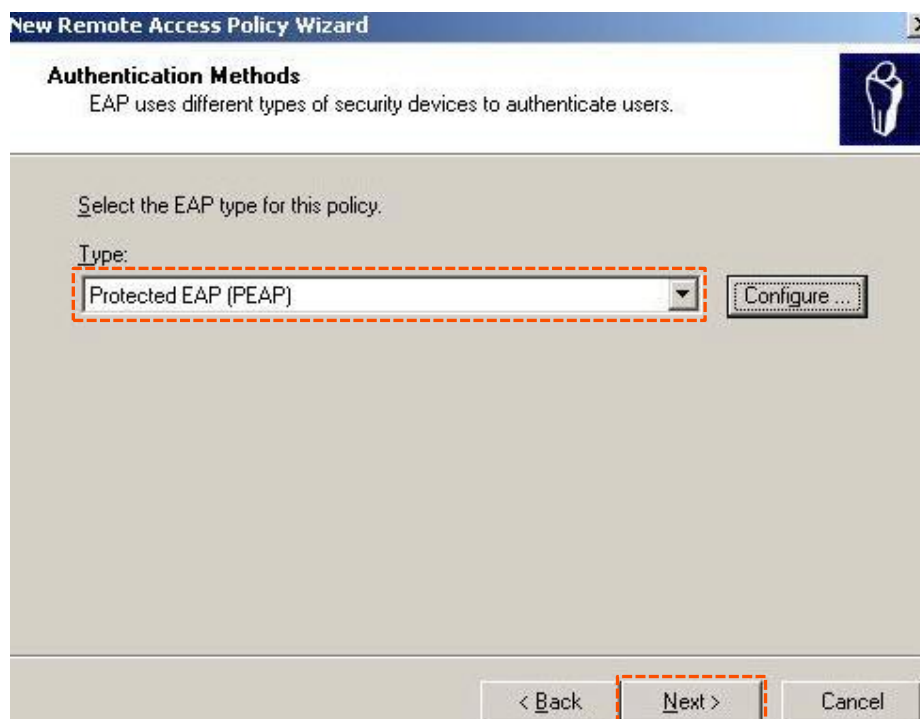

- (8) Click **Finish**. The remote access policy is created.

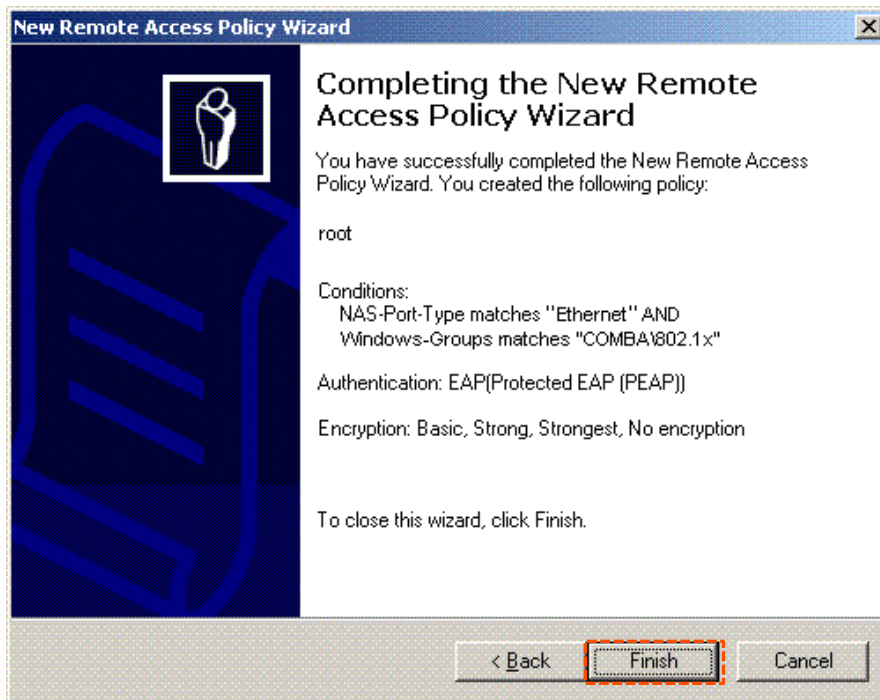

- (9) Right-click **root** and choose **Properties**. Select **Grant remote access permission**, select **NAS-Port-Type matches "Ethernet" AND**, and click **Edit**.

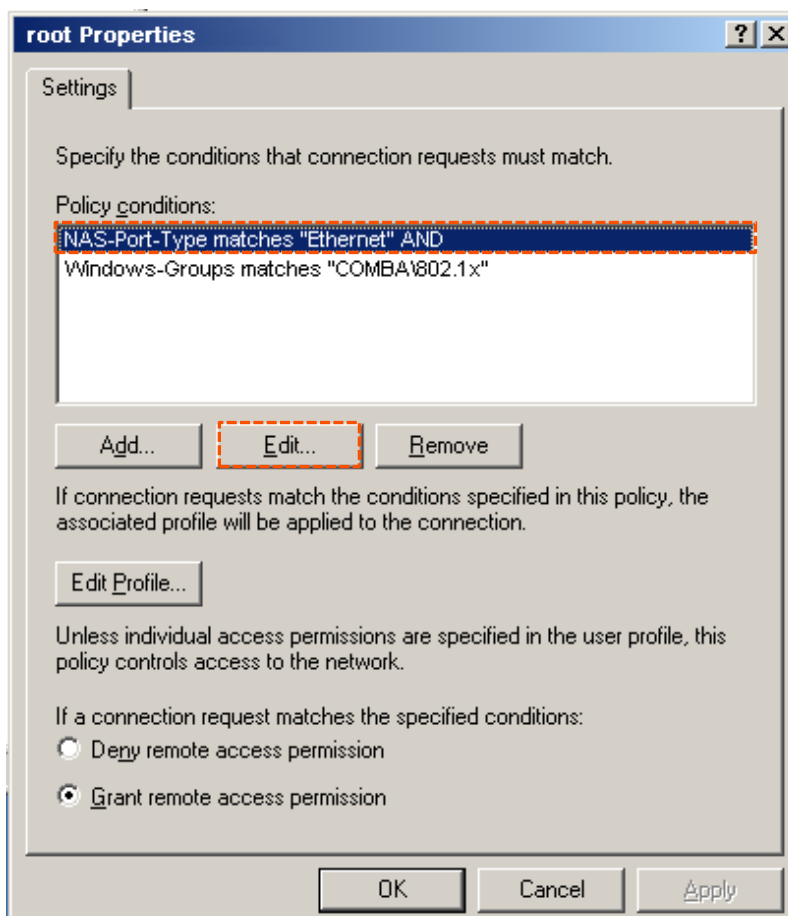

- (10) Select **Wireless – Other**, click **Add**, and click **OK**.

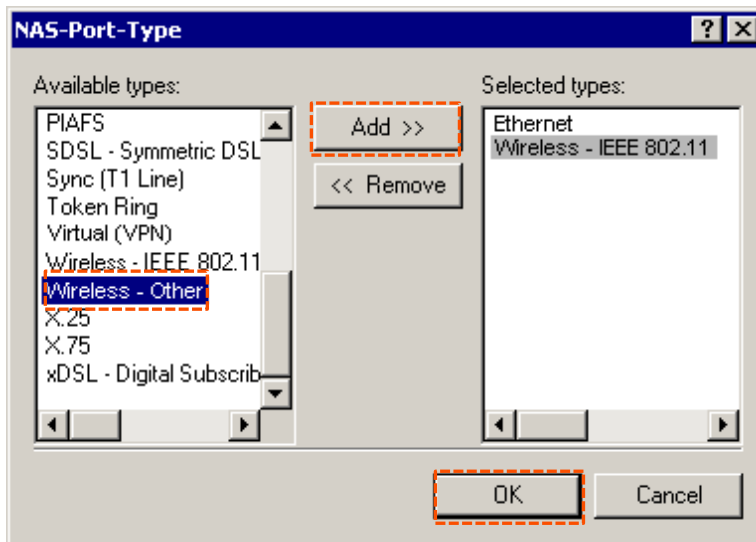

- (11) Click **Edit Dial-in Profile**, click the **Authentication** tab, configure settings as shown in the following figure, and click **OK**.

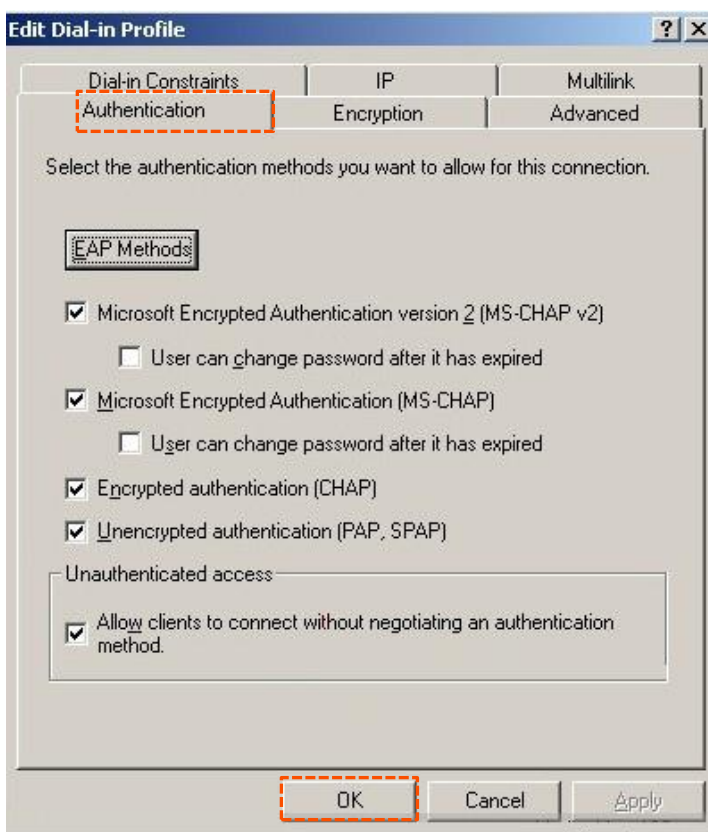

- (12) When a message appears, click **No**.

3. Configure user information.

Create a user and add the user to group **802.1x**.

Step 3 Configure wireless settings on the wireless client (Example: **Windows 7**)

- (1) Choose **Start > Control Panel**, click **Network and Internet**, click **Network and Sharing Center**, and click **Manage wireless networks**.

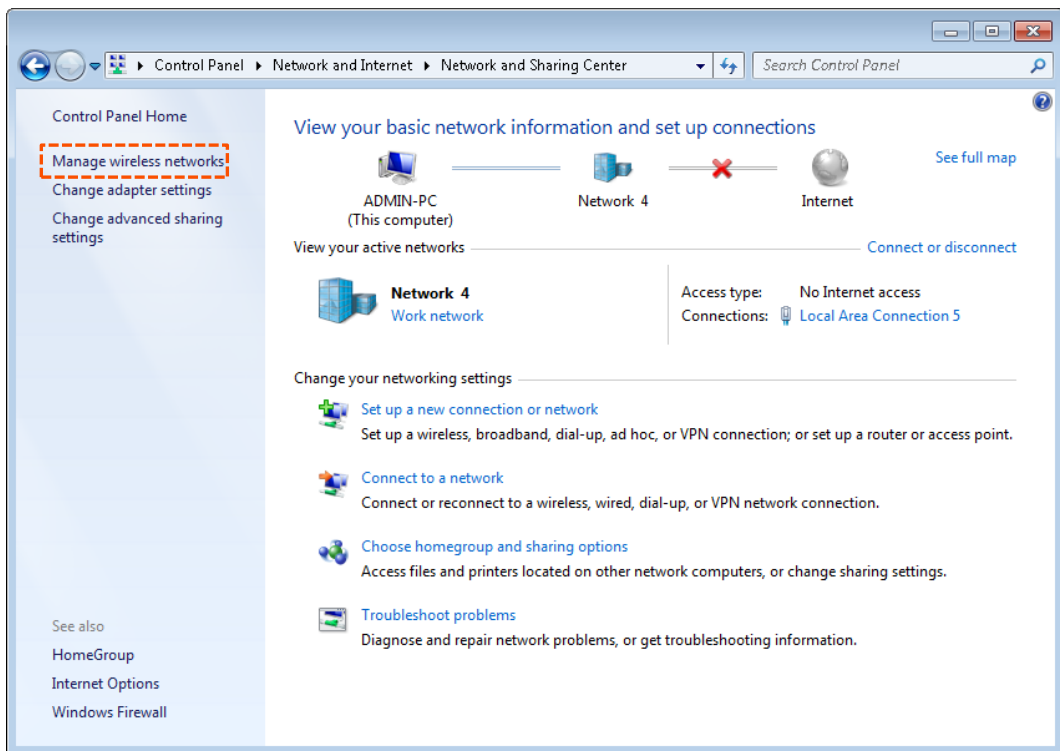

(2) Click **Add**.

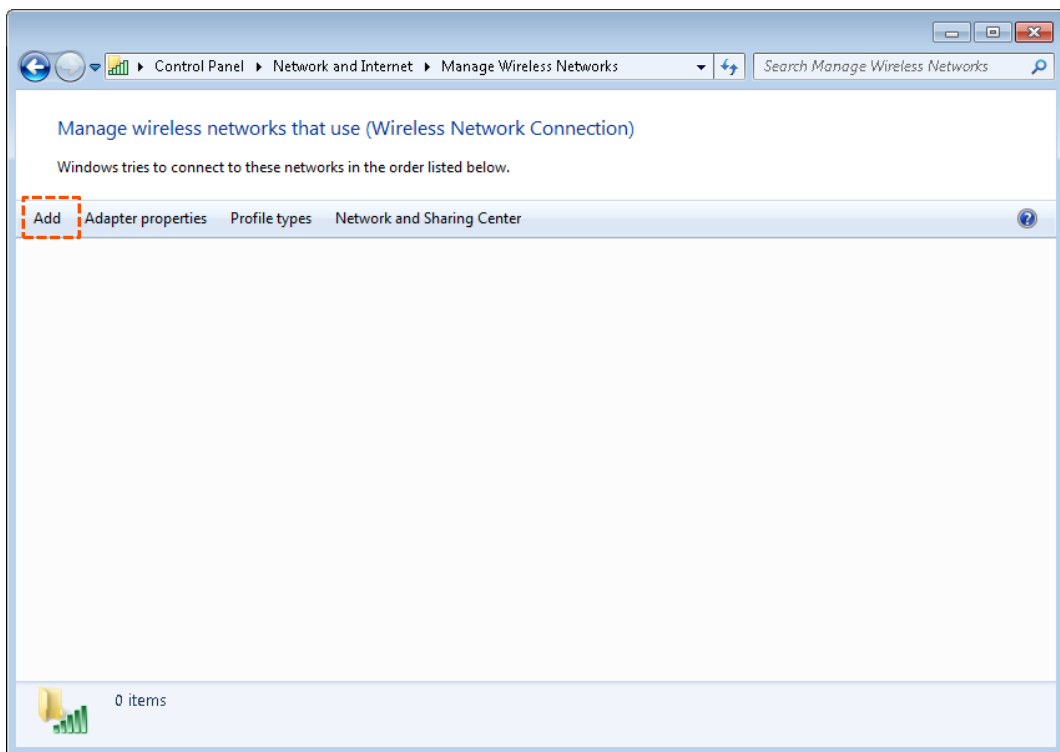

(3) Click **Manually create a network profile**.

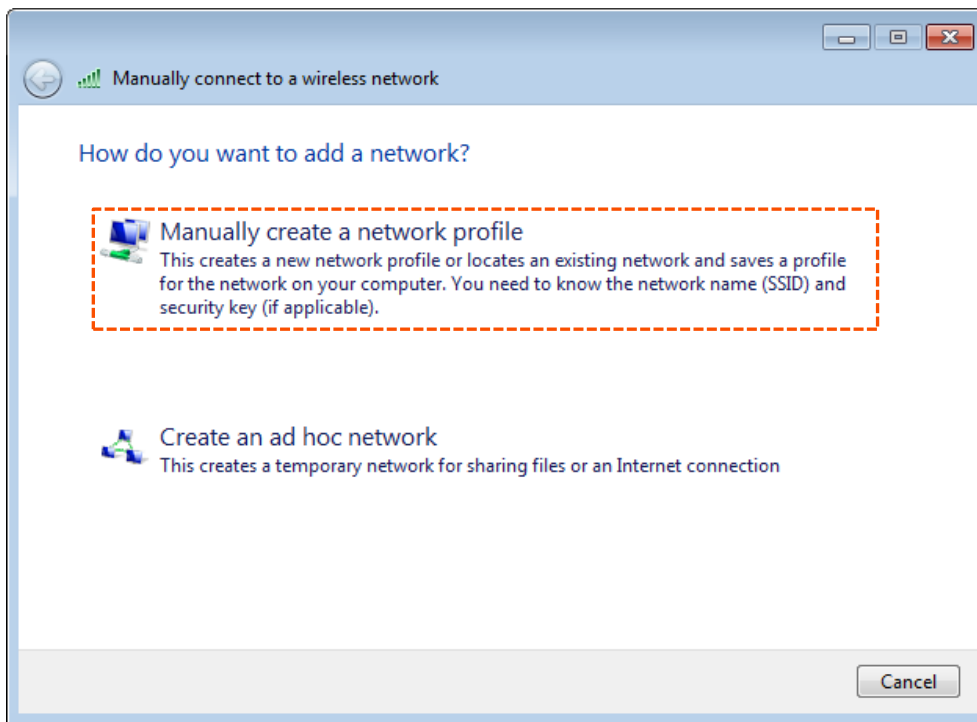

- (4) Enter WiFi network information, select **Connect even if the network is not broadcasting**, and click **Next**.

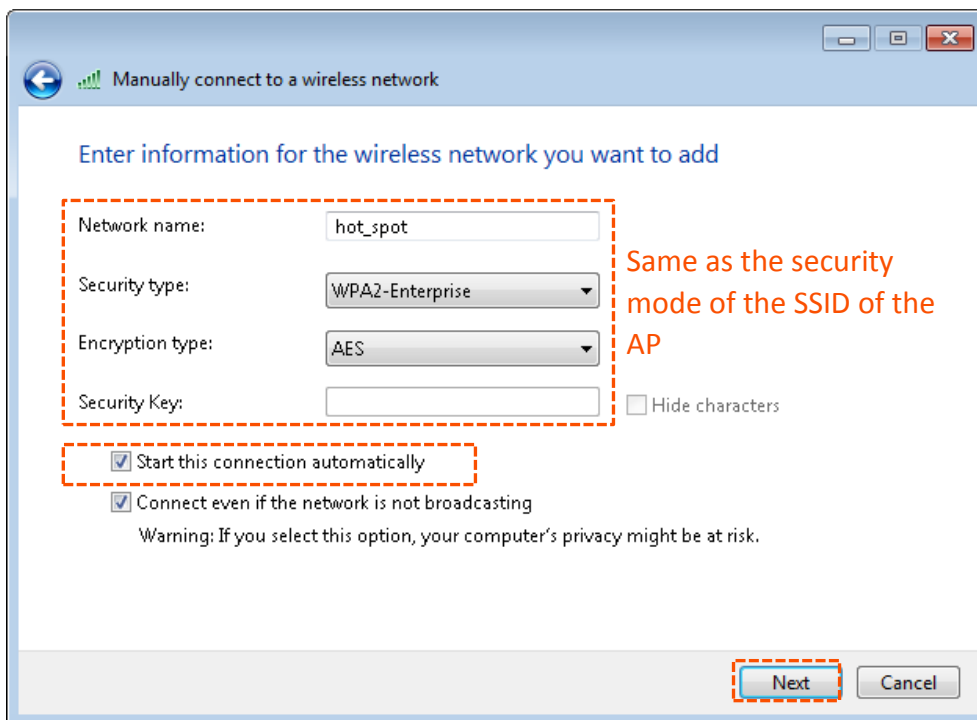

- (5) Click **Change connection settings**.

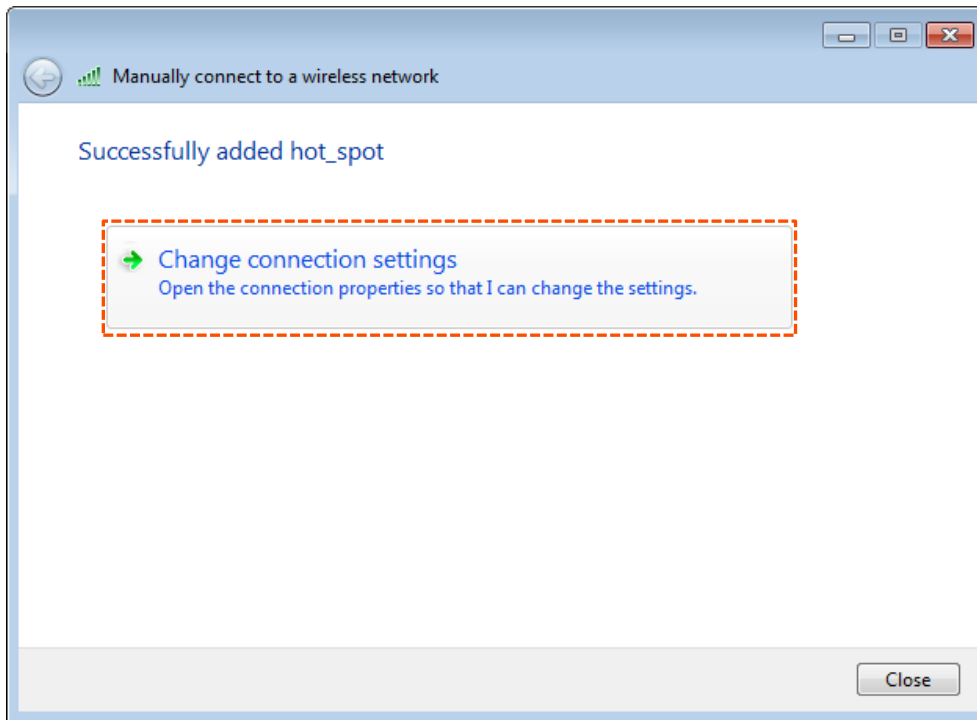

- (6) Click the **Security** tab, select **Microsoft: Protected EAP (PEAP)**, and click **Settings**.

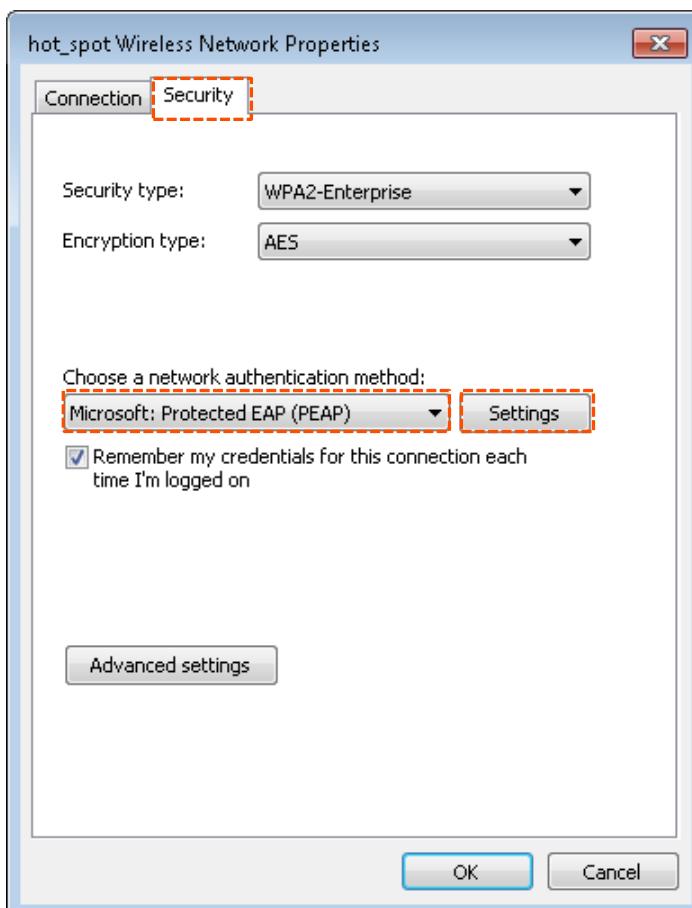

- (7) Deselect **Validate server certificate** and click **Configure**.

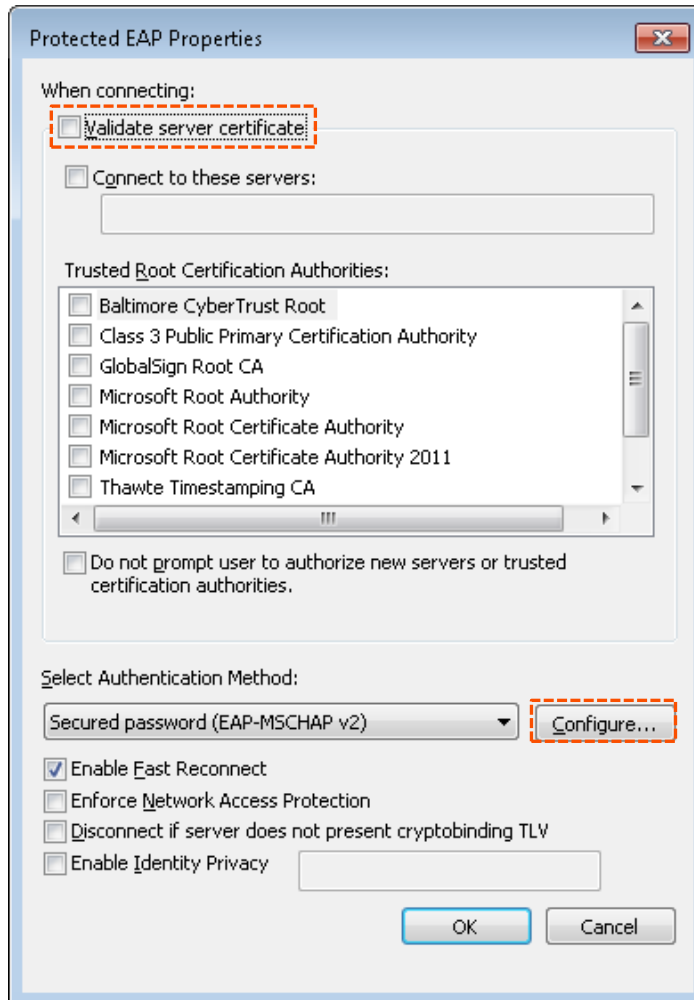

- (8) Deselect **Automatically use my Windows logon name and password (and domain if any)** and click **OK**.

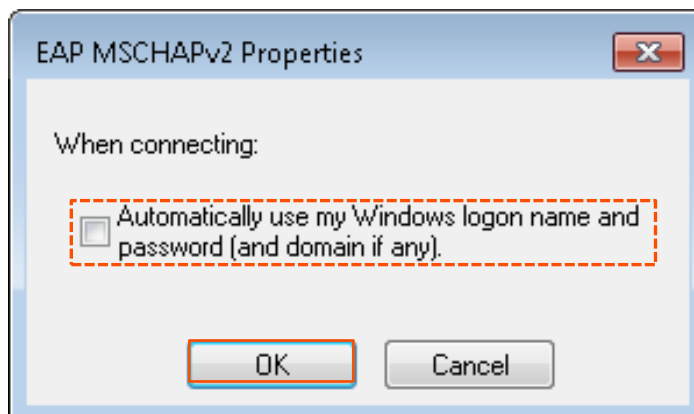

- (9) Click **Advanced settings**.

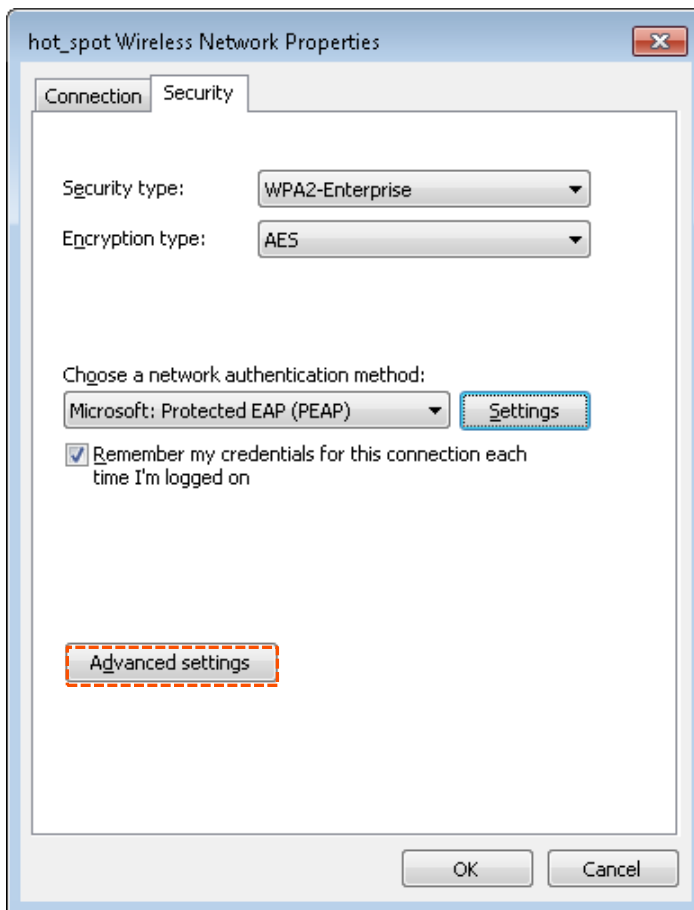

(10) Select **User or computer authentication** and click **OK**.

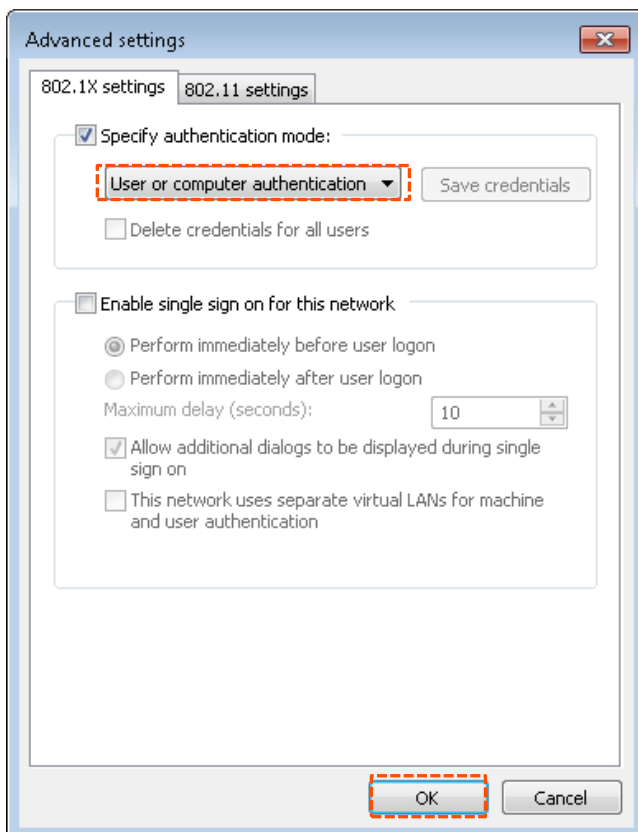

(11) Click **Close**.

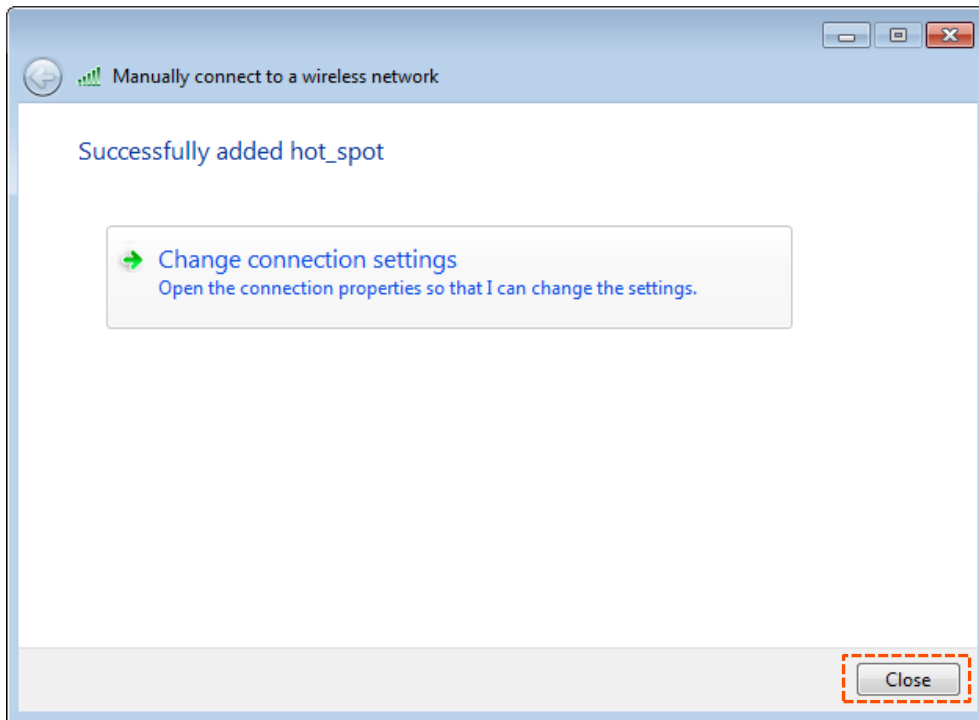

---- End

Verification

Step 1 Click the network icon in the lower-right corner of the desktop and choose the WiFi network of the AP, which is **hot_spot** in this example.

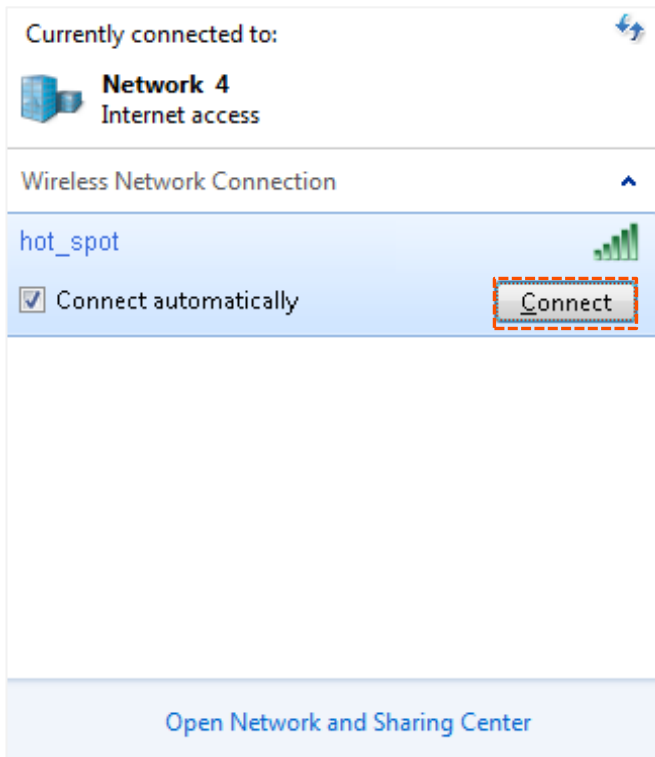

Step 2 In the **Windows Security** dialog box that appears, enter the user name and password set on the RADIUS server and click **OK**.

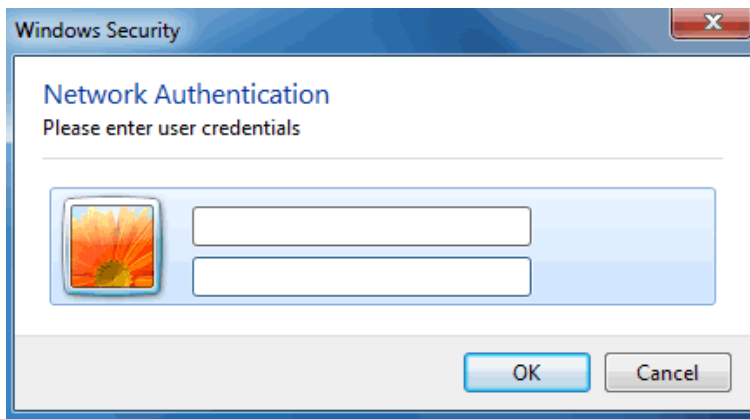

---- End

5.2 RF settings

5.2.1 Overview

RF (Radio Frequency) settings allow you to configure advanced settings about the AP, such as channel, power, short GI etc.

To enter the configuration page, choose **Wireless > RF Settings**.

The screenshot shows the RF Settings configuration page for a 2.4 GHz network. The page has a header with "2.4 GHz" and "5 GHz" tabs. A question mark icon is in the top right corner. The settings are as follows:

- Wireless Network:
- Country/Region:
- Network Mode:
- Channel:
- Channel Bandwidth:
- Lock Channel:
- Transmit Power: (10dBm to 23dBm)
- Lock Power:
- Preamble: Long Preamble Short Preamble
- Short GI: Enable Disable
- Suppress Broadcast Probe Response: Enable Disable

Buttons: Save (orange), Cancel (white)

Parameter description

Parameter	Description
Wireless Network	It specifies whether to enable the radio function of the AP.
Country/Region	It specifies the country or region where the AP is used.  It is the installer's responsibility to comply with channel regulations of the country or

Parameter	Description
	region.
Network Mode	<p>It specifies the wireless network mode (also called 802.11 mode, radio mode, or wireless mode) of the AP. A proper network mode enables the clients to get the maximum transfer rate and compatibility.</p> <p>Available options for 2.4 GHz band: 11b, 11g, 11b/g, and 11b/g/n (default).</p> <p>Available options for 5 GHz band: 11a, 11ac (default), and 11a/n mixed.</p> <p>You are recommended to keep the default settings.</p>
Channel	<p>It specifies the operating channel of the AP. To configure this parameter, deselect Lock Channel.</p> <p>Auto indicates that this device automatically changes to a channel rarely used in the ambient environment to prevent interference.</p>
Channel Bandwidth	<p>It specifies the wireless channel bandwidth of the AP.</p> <p>Available options for 2.4 GHz band: 20MHz (default), 40MHz, and 20/40MHz.</p> <p>Available options for 5 GHz band: 20MHz, 40MHz, and 80 MHz (default).</p>
Extension Channel	<p>It specifies the wireless extension channel of the AP.</p> <p>Available only when Channel Bandwidth is set to 40MHz, and 20/40MHz on 2.4 GHz band.</p>
Lock Channel	<p>If selected, Country/Region, Network Mode, and channel-related parameters (including Channel Bandwidth and Extension Channel) become dim and cannot be modified. By default, it is selected.</p>
Transmit Power	<p>Transmit power of this device.</p> <p>A higher value leads to wider WiFi coverage. However, decreasing the value properly increases performance and security of the wireless network.</p> <p>To adjust it, deselect Lock Power first.</p>
Lock Power	<p>If selected, the Transmit Power cannot be adjusted. By default, it is selected.</p>
Preamble	<p>It specifies a group of bits located at the beginning of a packet, according to which the receiver of the packet can perform synchronization and prepare for receiving data.</p> <p>By default, the Long Preamble option is selected for compatibility with old network adapters installed on wireless devices.</p>
Short GI	<p>Short guard interval for preventing data block interference.</p> <p>Propagation delays may occur on the receiver side due to factors such as multipath wireless signal transmission. If a data block is transmitted at an overly high speed, it may interfere with the previous data block. The short GI helps prevent such interference. Enabling the short GI can yield a 10% improvement in wireless data throughput.</p>
Suppress Broadcast Probe Response	<p>Whether or not to suppress the broadcast probe response.</p> <p>If enabled, this device does not respond to the requests without an SSID, saving</p>

Parameter	Description
	wireless resources.

5.2.2 Configuring RF settings

To enter the configuration page, choose **Wireless > RF Settings** first.

By default, dimmed parameters, including channel-related parameters and transmit power cannot be modified or adjusted. To modify or adjust these parameters, you need to deselect **Lock Channel** and/or **Lock Power** first.

Modify or adjust these parameters according to your actual requirement.

5.3 RF optimization

5.3.1 Overview

The AP allows you to configure advanced settings about radio frequency to optimize the AP performance. Please modify these parameters under the professional guidance.

To enter the configuration page, choose **Wireless > RF Optimization**.

The screenshot shows the RF Optimization configuration page for 2.4 GHz and 5 GHz. The page includes the following settings:

- Beacon Interval:** 100 ms (Range: 40 to 999. Default: 100)
- Fragment Threshold:** 2346 (Range: 256 to 2346. Default: 2346)
- RTS Threshold:** 2347 (Range: 1 to 2347. Default: 2347)
- DTIM Interval:** 1 (Range: 1 to 255. Default: 1)
- RSSI Threshold:** -90 dBm (Range: -90 to -60. Default: -90)
- Signal Transmission:** Coverage-oriented Capacity-oriented
- Air Interface Scheduling:** Enable Disable
- Anti-interference Mode:** 3 (Suppress critical inter) (Range: 0 to 3. Default: 3)
- APSD:** Enable Disable
- Client Timeout Interval:** 10min
- Mandatory Rate:** 1 2 5.5 6 9 11 12 18 24 36 48 54 All
- Optional Rate:** 1 2 5.5 6 9 11 12 18 24 36 48 54 All

Buttons: **Save** (highlighted in orange), **Cancel**

Parameter description

Parameter	Description
Beacon Interval	It specifies the interval for transmitting the Beacon frame. The Beacon frame is transmitted at the specified interval to announce the presence of a wireless network. Generally, a smaller interval enables wireless devices to connect to the AP more quickly, while a larger interval ensures higher data transmission speed for the AP.

Parameter	Description
Fragment Threshold	<p>It specifies the threshold of a fragment. Unit: byte.</p> <p>Fragmenting is a process that divides a frame into several fragments, which are transmitted and acknowledged separately. If the size of a frame exceeds this threshold, the frame is fragmented.</p> <p>In an environment of high error rate, you can reduce the threshold to enable the AP to resend only the fragments that have not been sent successfully, so as to increase the frame throughput.</p> <p>In an environment without interference, you can increase the threshold to reduce the number of acknowledgement times, so as to increase the frame throughput.</p>
RTS Threshold	<p>It specifies the frame length threshold for triggering the RTS/CTS mechanism. Unit: byte.</p> <p>If a frame exceeds this threshold, the RTS/CTS mechanism is triggered to reduce conflicts.</p> <p>Set the RTS threshold based on the actual situation. An excessively small value increases the RTS frame transmission frequency and bandwidth requirement. A higher RTS frame transmission frequency enables a WiFi network to recover from conflicts quicker. For a WiFi network with high user density, you can reduce this threshold for reducing conflicts. The RTS mechanism requires some network bandwidth. Therefore, it is triggered only when frames exceed this threshold.</p>
Signal Transmission	<ul style="list-style-type: none"> • Coverage-oriented: This mode broadens WiFi coverage of APs, and is usually used in scenarios deployed with fewer APs, such as offices, warehouses, and hospitals. • Capacity-oriented: This mode effectively decreases mutual interference among APs, and is usually used in scenarios deployed with massive APs, such as conferences, exhibition halls, banquet halls, stadiums, classrooms of higher-education institutes, airports and so on.
DTIM Interval	<p>It specifies the interval for transmitting the Delivery Traffic Indication Message (DTIM) frame. Unit: Beacon.</p> <p>A countdown starts from this value. The AP transmits broadcast and multicast frames in its cache only when the countdown reaches zero.</p> <p>For example, if DTIM Interval is set to 1, the AP transmits all cached frames after each beacon frame is transmitted.</p>
RSSI Threshold	<p>Set a minimum strength of received signals acceptable to the AP. If the strength of the signals transmitted by a wireless device is weaker than this threshold, the wireless device cannot connect to the AP.</p> <p>If there are multiple APs, an appropriate RSSI Threshold ensures that wireless devices can connect to the AP' WiFi networks with strong signals.</p>
Prioritize 5 GHz	<p>If enabled, devices that support 5 GHz band choose to connect the AP's 5 GHz WiFi network first. Otherwise, they randomly connect to 2.4GHz or 5 GHz WiFi network. This option is available on the 5 GHz configuration page.</p> <p> TIP</p> <p>The default RSSI threshold to enable this function is -80 dBm. You can adjust the</p>

Parameter	Description
	threshold by customizing the Prioritize 5 GHz Threshold parameter.
Prioritize 5 GHz Threshold	<p>It specifies the RSSI threshold value to trigger the Prioritize 5 GHz function. The default value is -80 dBm.</p> <p>You are recommended to keep the default settings.</p>
Air Interface Scheduling	<p>It specifies whether to enable the air interface scheduling function.</p> <p>This function allows all clients to transmit data for the same duration. If a client transmits data at a low speed and does not finish data transmission within the duration, it can continue transmitting data only in its next data transmission duration. This prevents some slow clients from occupying excessive airtime resources, so as to improve the overall AP efficiency and effectively ensure AP connections for a larger number of clients and greater throughputs.</p>
Anti-interference Mode	<p>Select an interference mitigation mode for your AP.</p> <p>Available options include: 0 (Disable), 1 (Suppress weak interference), 2 (Suppress moderate interference), and 3 (Suppress critical interference).</p>
APSD	<p>Automatic Power Save Delivery.</p> <p>APSD is a WMM power saving protocol created by Wi-Fi Alliance. Enabling APSD helps reduce power consumption. By default, this mode is disabled.</p>
MU-MIMO	<p>Multi-User Multiple-Input Multiple-Output.</p> <p>If enabled, AP can communicate with multiple users concurrently, avoiding WiFi network congestion and improving communication. This option is available on the 5 GHz configuration page.</p>
Client Timeout Interval	<p>It specifies the maximum period before a WiFi client is disconnected from the AP if the client exchanges no data with the AP. When data is exchanged within the period, countdown stops.</p>
Mandatory Rate	<p>It specifies that any connected wireless clients that support the data rate options ticked here may communicate with the router using that rate.</p>
Optional Rate	<p>You are recommended to keep the default settings. If you need to modify them, please do under professional guidance.</p>

5.3.2 Modifying radio optimization settings



You are strongly recommended to modify the settings only with professional guidance to prevent degrading wireless performance.

To enter the configuration page, choose **Wireless > RF Optimization** first.



The following takes configuration on 2.4 GHz band for example. Configuration on 5 GHz is identical.

Procedure

Step 1 Locate and modify the parameters as required.

Step 2 Click **Save** to apply your settings.

---- **End**

5.4 Frequency analysis

This section introduces how to evaluate signal interference in ambient environment. You can use the analysis result to help you configure the AP for best performance.

This module consists of **Frequency Analysis** and **Channel Scan**. Choose **Wireless > Frequency Analysis**, and click the corresponding tab to enter the page.

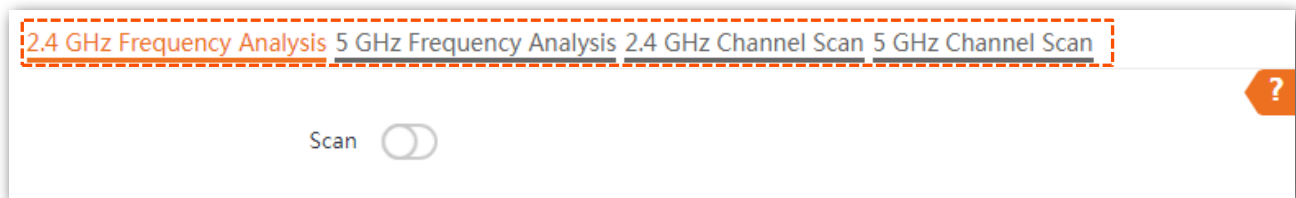

5.4.1 Viewing frequency analysis

From the intuitive result, you can read how many wireless networks (total SSID) use the same channel. See the following figure.

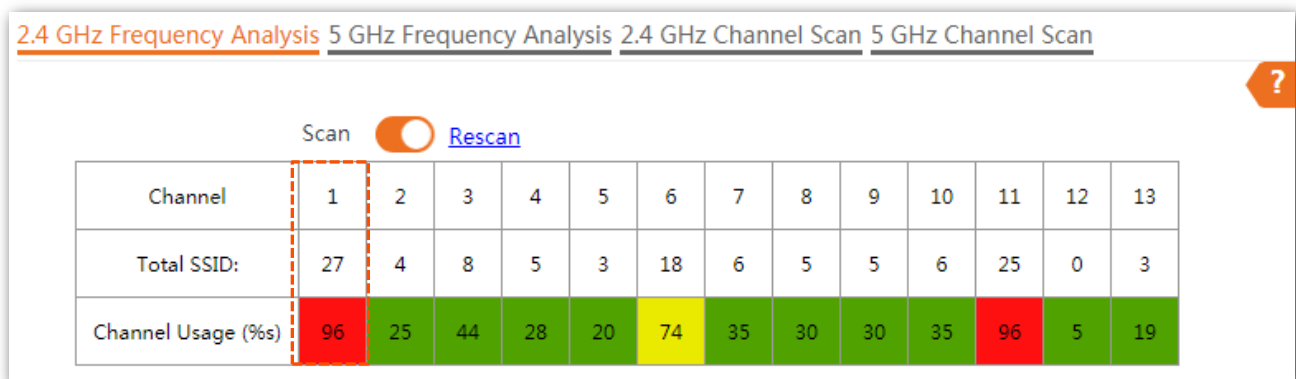

TIP

Color-code explanation:

■ Red: High channel usage. The channel is not recommended to use.

■ Yellow: Moderate channel usage.

■ Green: Low channel usage. The channel is recommended to use.

5.4.2 Executing channel scan

The scan result list presents you with information about nearby wireless network, including SSID, MAC address, channel, channel bandwidth, security mode, and signal strength. See the following figure.



Scan [Rescan](#)

ID	SSID	MAC Address	Channel Bandwidth	Channel	Security Mode	Signal Strength
1	Tenda_Router	D8:32:14:4C:CB:71	20MHz	1	Mixed WPA/WPA2-PSK...	-25dBm
2	Tenda_72EFE8	C8:3A:35:72:EF:E9	20MHz	7	Mixed WPA/WPA2-PSK...	

5.5 WMM

5.5.1 Overview

WMM is a wireless QoS protocol used to ensure that packets with high priorities are transmitted first. This ensures better experience of voice and video service over WiFi networks.

WMM involves the following terms:

- **Enhanced Distributed Channel Access (EDCA):** It is a channel competition mechanism to ensure that packets with higher priorities are assigned more bandwidth and transmitted earlier.
- **Access Category (AC):** The WMM mechanism divides WLAN traffic by priority in descending order into the AC-VO (voice stream), AC-VI (video stream), AC-BE (best effort), and AC-BK (background) access categories. The access categories use queues with different priorities to send packets. The WMM mechanism ensures that packets in queues with higher priorities have more opportunities to access channels.

According to the 802.11 protocol family, all devices listen on a channel before using the channel to send data. If the channel stays idle for or longer than a specified period, the devices wait a random backoff period within the contention window. The device whose backoff period expires first can use the channel. The 802.11 protocol family applies the same backoff period and contention window to all devices across a network to ensure that the devices have the same channel contention opportunity.

■ **ACK Policies**

WMM specifies the Normal ACK and No ACK policies.

- According to the No ACK policy, no ACK packet is used during wireless packet transmission to acknowledge packet reception. This policy is applicable to scenarios where interference is mild and can effectively improve transmission efficiency. In case of strong interference, lost packets are not sent again if this policy is adopted. This leads a higher packet loss rate and reduces the overall performance.
- According to the Normal ACK policy, each time a receiver receives a packet, it sends back an ACK packet to acknowledge packet reception.

■ **EDCA Parameters**

802.11 networks offer wireless access services based on the Carrier Sense Multiple Access with Collision Avoidance (CSMA/CA) channel competition mechanism, which allows all wireless devices to fairly compete for channels. All the services implemented over WiFi networks share the same channel competition parameters. Nevertheless, different services usually have different requirements for bandwidth, delay, and jitter. This requires wireless networks to offer accessibility based on the services implemented over the networks.

WMM changes the contention mechanism of 802.11 networks by dividing packets into four ACs, among which the ACs with higher priorities have more opportunities to access channels. The ACs help achieve different service levels.

WMM assigns each AC a set of EDCA parameters for channel contention, including:

- Arbitration Inter Frame Spacing Number (AIFSN): Different from the fixed distributed inter-frame spacing (DIFS) specified in the 802.11 protocol family, AIFSN varies across ACs. A greater AIFSN indicates a longer backoff period. See AIFS in the following figure.
- Contention window minimum (CW_{min}) and contention window maximum (CW_{max}) specify the average backoff period. The period increases along with these two values. See the backoff slots in the following figure.
- Transmission Opportunity (TXOP): It specifies the maximum channel use duration after successful channel contention. The duration increases along with this value. The value **0** indicates that a device can send only one packet through a channel after winning contention for the channel.

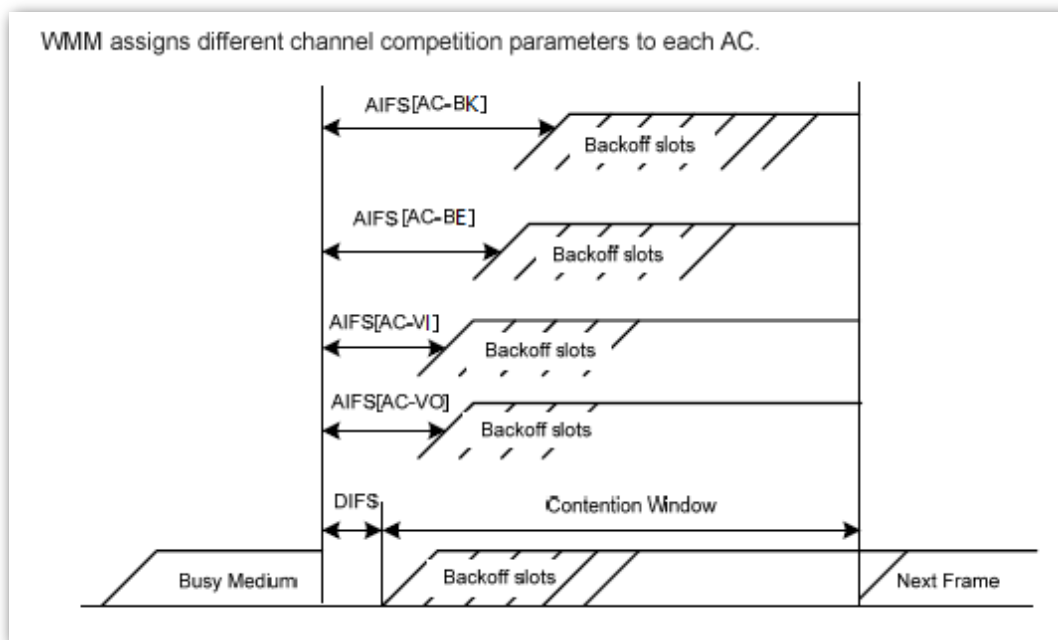

The AP offers **3** options for WMM optimization. You can choose the scenario-based (1 – 10 users, or over 10 users) option and let the AP help you optimize WMM automatically. Or you can choose **Custom** to configure the parameters yourself to meet your very specific requirement.

5.5.2 Configuring scenario-based WMM settings

Select either of the two and let the AP help you optimize WMM automatically.

To enter the configuration page, choose **Wireless > WMM**.

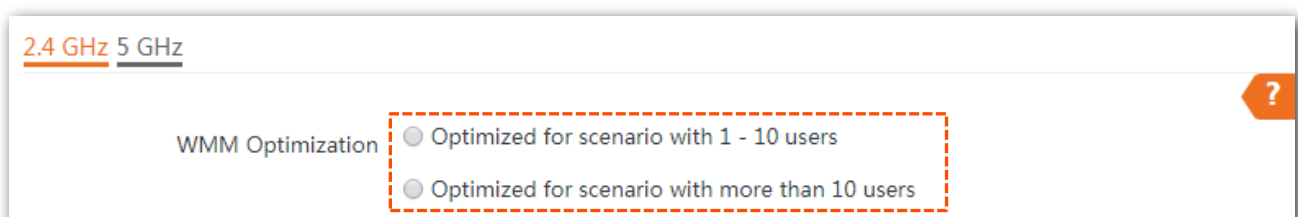

According to your actual situations, select **Optimized for scenario with 1 - 10 users** or **Optimized for scenario with more than 10 users**, and click **Save** to apply your settings.

5.5.3 Configuring WMM settings manually

Configure the parameters yourself to meet your very specific requirement.

Tick **Custom**, the following page appears. Customize the related parameters and click **Save** to apply your settings.

2.4 GHz 5 GHz
?

WMM Optimization

Optimized for scenario with 1 - 10 users
 Optimized for scenario with more than 10 users
 Custom

No ACK

EDCA AP Parameter

	CWmin	CWmax	AIFSN	TXOP Limit
AC_BE	<input type="text" value="4"/>	<input type="text" value="6"/>	<input type="text" value="3"/>	<input type="text" value="0"/>
AC_BK	<input type="text" value="4"/>	<input type="text" value="10"/>	<input type="text" value="7"/>	<input type="text" value="0"/>
AC_VI	<input type="text" value="3"/>	<input type="text" value="4"/>	<input type="text" value="1"/>	<input type="text" value="3008"/>
AC_VO	<input type="text" value="2"/>	<input type="text" value="3"/>	<input type="text" value="1"/>	<input type="text" value="1504"/>

EDCA STA Parameter

	CWmin	CWmax	AIFSN	TXOP Limit
AC_BE	<input type="text" value="4"/>	<input type="text" value="10"/>	<input type="text" value="3"/>	<input type="text" value="0"/>
AC_BK	<input type="text" value="4"/>	<input type="text" value="10"/>	<input type="text" value="7"/>	<input type="text" value="0"/>
AC_VI	<input type="text" value="3"/>	<input type="text" value="4"/>	<input type="text" value="2"/>	<input type="text" value="3008"/>
AC_VO	<input type="text" value="2"/>	<input type="text" value="3"/>	<input type="text" value="2"/>	<input type="text" value="1504"/>

Save
Cancel

Parameter description

Parameter	Description
No ACK	See ACK Policies .
EDCA AP Parameter	See EDCA Parameters .

Parameter	Description
EDCA STA Parameter	See EDCA Parameters .

5.6 Access control

This module allows you to configure MAC address-based wireless access control rules.

5.6.1 Overview

To enter the configuration page, choose **Wireless > Access Control**. By default, this function is disabled.

2.4 GHz 5 GHz

SSID: Tenda_01

Access Control:

Mode: Blacklist Whitelist

MAC Address: Format: XX:XX:XX:XX:XX:XX [Add] [Add Online Devices]

ID	MAC Address	Status	Operation
No data			

Parameter description

Parameter	Description
SSID	It specifies the SSID on which the MAC address access control is implemented.
Access Control	It specifies whether or not to enable this function.
Mode	<ul style="list-style-type: none">• Blacklist: Clients with MAC addresses on the access control list cannot access the wireless network of AP.• Whitelist: Client with MAC addresses on the access control list can access the wireless network of AP.

5.6.2 Configuring access control

To enter the configuration page, choose **Wireless > Access Control** first.



- Before configuration, obtain and note down the MAC address(es) of the target device(s).
- The following introduces how to configure on 2.4 GHz band. Configuration on 5 GHz is identical.

Procedure

Step 1 Select the SSID to which the access control is applied from the **SSID** drop-down list menu.

Step 2 Enable **Access Control**.

Step 3 Select the control **Mode** as required.

Step 4 Add the MAC address of the client.

Option 1: Enter the MAC address manually

Enter the MAC address into the **MAC Address** box.

Option 2: Add online clients

1. Click **Add Online Devices**. The **Online Device** configuration window appears.

<input type="checkbox"/>	ID	IP Address	MAC Address	Connection Duration
<input type="checkbox"/>	1	192.168.1.147	54:B1:21:56:62:45	10sec

2. Select one or multiple devices by ticking the checkbox(es) next to **ID** column.
3. Click **Add**.

Step 5 Click **Save** to apply your settings.

2.4 GHz 5 GHz

SSID

Access Control

Mode Blacklist Whitelist

Toggle the button to enable or disable the rule.

MAC Address

ID	MAC Address	Status	Operation
1	54:B1:21:56:62:45	<input checked="" type="checkbox"/> Enable	<input type="button" value="Delete"/>

Click to delete the rule.

---- End

5.7 Advanced settings

This module enables you to make AP's WiFi network and wireless transmission more efficiently through enabling identifying client type and filtering broadcast packet. By default, these two functions are disabled.

To enter the configuration page, choose **Wireless > Advanced Settings**.

5.7.1 Identify client type



Enabling this function may impact on the wireless performance of the AP. Therefore, enable this function only when necessary.

With this function enabled, the AP can identify the operating system of the client connected to it. To enable this function, tick **Enable** next to the **Identify Client Type**, and click **Save**.

A screenshot of the 'Advanced Settings' configuration page. The page title is 'Advanced Settings' in orange. There are two radio button options: '* Identify Client Type' with 'Enable' selected, and 'Broadcast Packet Filter' with 'Disable' selected. Below these is a 'Filters' dropdown menu showing 'Excludes DHCP and AR'. At the bottom are 'Save' and 'Cancel' buttons. A help icon (question mark) is in the top right corner.

You can view the client type information by navigating to **Status > Client List**.



The AP identifies the client type on two conditions:

- The **Identity Client Type** function is enabled.
- The client connected to the AP has accessed an **http://** website.

Otherwise, -- is displayed.

5.7.2 Broadcast packet filter



You are strongly recommended to configure this function only under the professional guidance to prevent degrading the WiFi performance of the AP.

By default, the AP will forward lots of invalid broadcast packets, which may affect normal packets transmission. However, this function can filter broadcast packets and reduce airtime consumption, ensuring bandwidth of normal packets transmission.

The AP supports to filter broadcast packets and allows you to keep DHCP and ARP packets, or ARP packets only.

To enter the configuration page, choose **Wireless > Advanced Settings** first.

Procedure

Step 1 Tick **Enable** next to the **Broadcast Packet Filter**.

Step 2 Select the broadcast packets you do not want to filter from the drop-down list menu of **Filters**.

Step 3 Click **Save** to apply your settings.

The screenshot shows the 'Advanced Settings' configuration page. At the top, there is a '?' icon in an orange box. Below it, there are two radio button options: 'Identify Client Type' with 'Enable' and 'Disable' options, where 'Disable' is selected. Below that, there is a red asterisk followed by 'Broadcast Packet Filter' with 'Enable' and 'Disable' options, where 'Enable' is selected. Below that, there is a red asterisk followed by 'Filters' and a dropdown menu. The dropdown menu is open, showing three options: 'Excludes DHCP and AR', 'Excludes DHCP and ARP', and 'Excludes ARP'. The 'Save' button is highlighted in orange, and the 'Cancel' button is in white with a grey border.

---- End

5.8 QVLAN settings

This AP supports the IEEE 802.1q VLAN function and can work with switches supporting that function to establish multiple VLANs. Devices connecting to VLANs with different VLAN IDs cannot communicate with each other. By default, the AP's QVLAN function is disabled.

5.8.1 Overview

To enter the configuration page, choose **Wireless > QVLAN Settings**.

QVLAN Settings

QVLAN

PVID

Management VLAN

2.4 GHz SSID VLAN ID (1 to 4094)

Tenda_01

5 GHz SSID VLAN ID (1 to 4094)

Tenda_1487E8_5G

Parameter description

Parameter	Description
QVLAN	It specifies whether to enable the QVLAN function of the AP. By default, it is disabled.
PVID	Port-based VLAN ID. It specifies the ID of the default native VLAN of the trunk port of the AP. The default value is 1 .
Management VLAN	It specifies the ID of the AP management VLAN. The default value is 1 . After changing the management VLAN, you can manage the AP only after connecting your computer or AP controller to the new management VLAN.
2.4 GHz SSID	It specifies the currently enabled SSID(s) over the 2.4 GHz band of the AP.
5 GHz SSID	It specifies the currently enabled SSID(s) over the 5 GHz band of the AP.

Parameter	Description
VLAN ID	It specifies the VLAN IDs corresponding to SSIDs. By default, this value is 1000 . After the QVLAN function is enabled, the wireless ports corresponding to SSIDs functions as access ports. The PVID of an access port is the same as its VLAN ID.

If the QVLAN function is enabled, tagged data received by a port of the AP is forwarded to the other ports of the VLAN corresponding to the VID in the data, whereas untagged data received by a port of the AP is forwarded to the other ports of the VLAN corresponding to the PVID of the port that receives the data.

The following table describes how ports of different link types process transmitted and received data.

Port	Method to process received data		Method to process transmitted data
	Tagged data	Untagged data	
Access			Transmit data after removing tags from the data.
Trunk	Forward the data to other ports of the VLAN corresponding to the VID in the data.	Forward the data to the other ports of the VLAN corresponding to the PVID of the port that receives the data.	<p>If the VID and PVID of a port are the same, transmit data after removing tags from the data.</p> <p>If the VID and PVID of a port are different, transmit data without removing tags from the data.</p>

5.8.2 Example of configuring QVLAN

Networking requirement

A hotel has the following WiFi network coverage requirements:

- Guests are allowed to connect to VLAN2 and only able to access the internet.
- Hotel staffs are allowed to connect to VLAN3 and only able to access the intranet.
- Hotel administrators are allowed to connect to VLAN4, able to access both the intranet and the internet.

Assume that the SSID for guests is **internet**, the SSID for staffs is **oa** and the SSID for administrators is **VIP**. The SSIDs are enabled and configured successfully on the AP.

Network topology

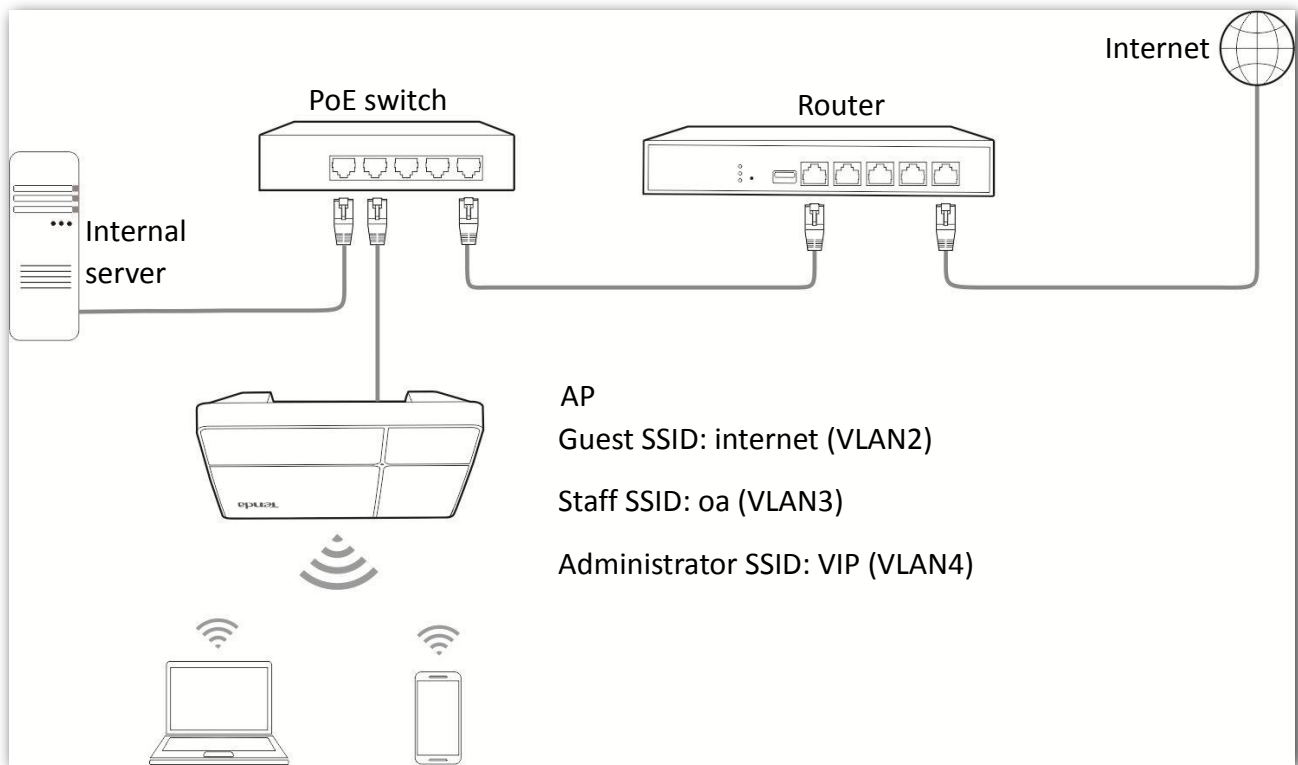

Configuration description

Configuring QVLAN function involves operations across various devices. This guide will walk you through the configuration step by step.

The following table summarizes the overall steps. Get yourself familiar with the whole process before you start.

Step	Task	Description
1	Configure the AP.	Enable QVLAN on the AP, and set required parameters.
2	Configure the switch.	Create IEEE 802.1q VLANs on the switch as required.
3	Configure the router and the internal server.	Enable QVLAN function on your router and internal server, and configure parameters as required.

Procedure

Step 1 Configure the AP.

1. Log in to the web UI of the AP and choose **Wireless > QVLAN Settings**.
2. Enable **QVLAN**.
3. Modify the VLAN IDs as shows in the following figure.

QVLAN Settings ?

* QVLAN

PVID

Management VLAN

* 2.4 GHz SSID VLAN ID (1 to 4094)

* internet

* oa

* VIP

4. Click **Save** to apply your settings.
5. Click **OK**. And wait for the AP completes rebooting.

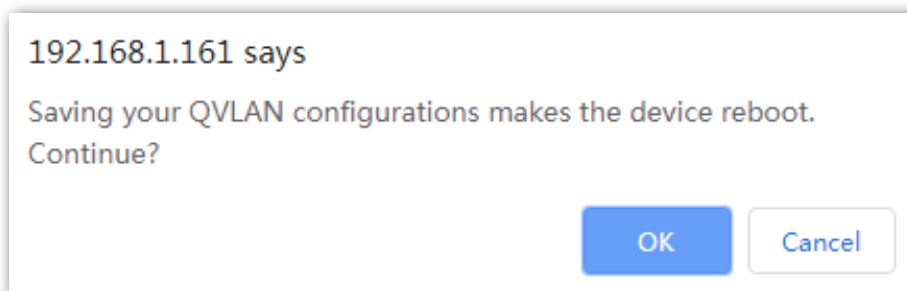

Step 2 Configure the switch.

Create IEEE 802.1q VLANs described in the following table on the switch. Retain the default settings of other ports. For details, refer to the user guide of the switch.

Port Connected To	Accessible VLAN ID	Port Type	PVID
AP	1, 2, 3, 4	Trunk	1
Internal server	3, 4	Trunk	1
Router	2, 4	Trunk	1

Step 3 Configure the router and the internal server.

To ensure your wireless devices connected to the AP can access the internet, you should configure QVLAN function on your router and internal server which support QVLAN function. Detailed VLAN parameters are listed as follows:

VLAN parameters configured on your router:

Port Connected To	Accessible VLAN ID	Port Type	PVID
Switch	2, 4	Trunk	1

VLAN parameters configured on your internal server:

Port Connected To	Accessible VLAN ID	Port Type	PVID
Switch	3, 4	Trunk	1

For configuration details, refer to the user guides of your router and internal server.

---- End

Verification

Wireless devices connected to the SSID **internet** can access only the internet. Wireless devices connected to the SSID **oa** can access only the intranet. Wireless devices connected to the SSID **VIP** can access both the internet and the intranet.

6 Advanced

6.1 Deployment mode

If a large number of APs are deployed, you are recommended to adopt an Tenda AC (Access Controller) to manage the APs in a centralized manner. The AP supports **Local Deployment** (default) and **Cloud Deployment**.

6.1.1 Applicable scenarios

Deploy your network according to the following introduction to meet your very specific requirement.

- Local deployment

If you need to deploy many APs in a small area, you are recommended to set the AP in the local deployment mode, which uses a local AC (in Sub AC mode) to manage the APs in a centralized manner. The following figure shows the topology for the local deployment mode.

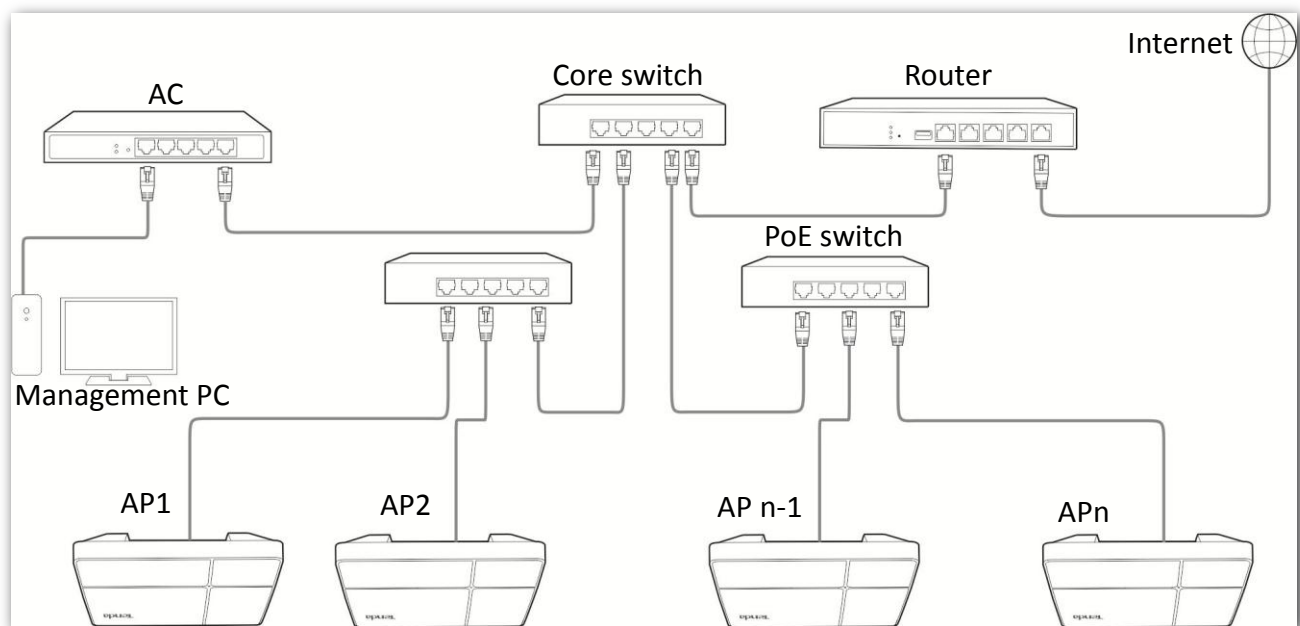

Cloud deployment

If you need to deploy many APs distributed across a large area, you are recommended to select the cloud deployment mode, which uses an AC (in Cloud AC mode) over the internet to manage the APs in a centralized manner. The following figure shows the topology for the cloud deployment mode.

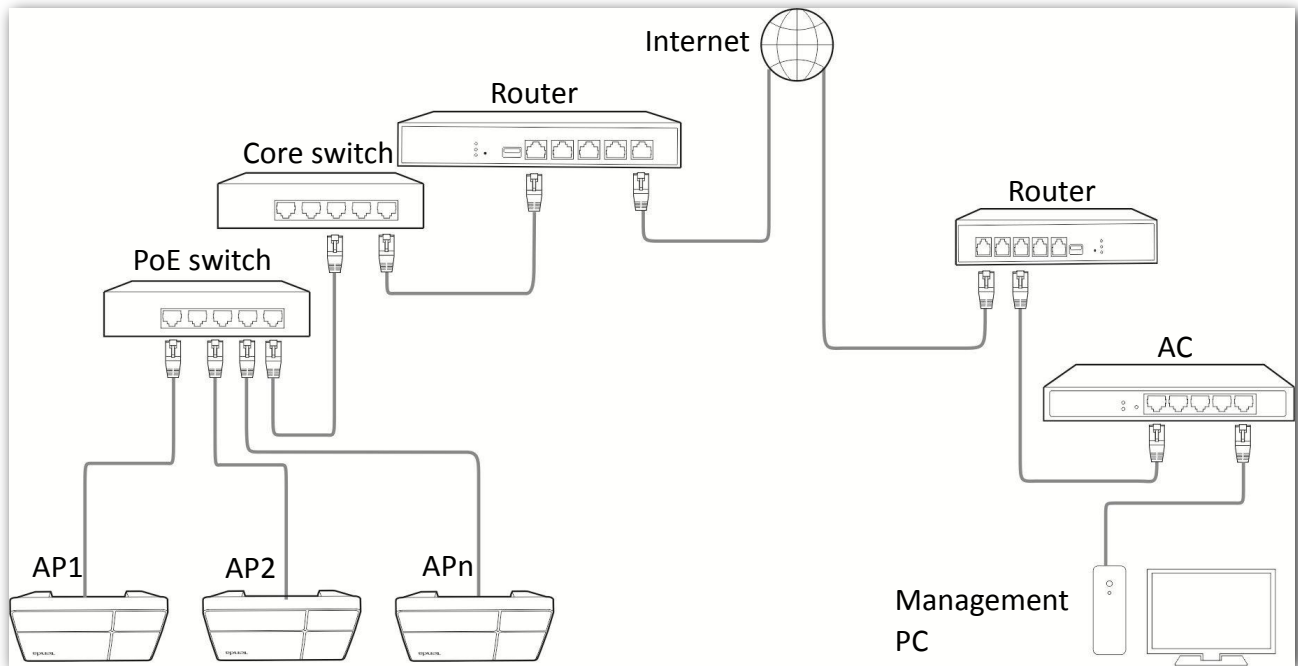

6.1.2 Introduction to deployment mode of the AP

To enter the configuration page, choose **Advanced > Deployment Mode**.

Deployment Mode

Deployment Mode Local Cloud

Device Name

Cloud AC Address

Cloud AC Management Port (Range: 1024 to 65535)

Cloud AC Upgrade Port (Range: 1024 to 65535)

Parameter description

Parameter	Description
Deployment Mode	<p>It specifies the deployment mode supported by the AP.</p> <ul style="list-style-type: none">• Local (default): It indicates that the AP can be managed only through the AC connected to the same local network.• Cloud: In this mode, the AP can be managed only by a cloud AC or a cloud server.
Device Name	<p>It specifies the device name of the AP.</p> <p> TIP</p> <ul style="list-style-type: none">• You can customize the device name here, or on Internet Settings > LAN Setup page. Modification of the device name is globally applied.• For later convenient management, you are recommended to customize the device name.
Cloud AC Address	<p>It specifies the WAN IP address of the router to which the cloud AC connects, or the domain name to which the router's WAN IP address is bound.</p>
Cloud AC Management Port	<p>It specifies port of the egress router to which the cloud AC connects for managing this device.</p>
Cloud AC Upgrade Port	<p>It specifies port of the egress router to which the cloud AC connects for upgrading this device.</p>

6.1.3 Configuring the cloud deployment mode

Procedure

Step 1 Click **Deployment**, and select **Cloud**.

Step 2 Set related parameters.

Step 3 Click **Save** to apply your settings.

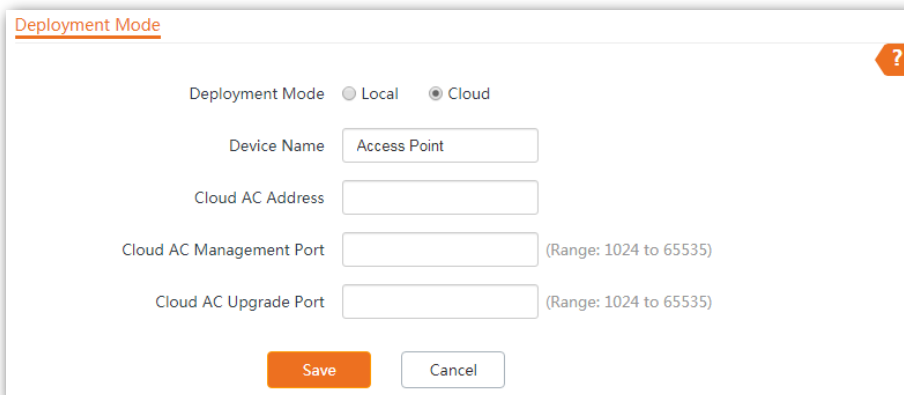

Deployment Mode

Deployment Mode Local Cloud

Device Name

Cloud AC Address

Cloud AC Management Port (Range: 1024 to 65535)

Cloud AC Upgrade Port (Range: 1024 to 65535)

---- End

6.2 SNMP

6.2.1 Overview

The Simple Network Management Protocol (SNMP) is the most widely used network management protocol in TCP/IP networks. SNMP enables you to remotely manage all your network devices compliant with this protocol, such as monitoring the network status, changing network device settings, and receiving network event alarms.

SNMP supports managing devices bought from various vendors automatically, regardless of physical differences among the devices.

SNMP management framework

The SNMP management framework consists of SNMP manager, SNMP agent, and Management Information Base (MIB).

- **SNMP manager:** It is a system that controls and monitors network nodes using the SNMP protocol. Network Management System (NMS) is the most widely used SNMP manager in network environments. An NMS can be a dedicated network management server, or an application that implements management functions in a network device.
- **SNMP agent:** It is a software module in a managed device. This module is used to manage data about the device and report the management data to an SNMP manager.
- **MIB:** It is a collection of managed objects, defining a series of attributes of managed objects, including names, access permissions, and data types of objects. Each SNMP agent has its own MIB. An SNMP manager can read and/or write objects in the MIB based on the permissions assigned to the SNMP manager.

An SNMP manager manages SNMP agents in an SNMP network. The SNMP manager exchanges management information with the SNMP agents using the SNMP protocol.

Basic SNMP operations

The AP supports the following basic SNMP operations:

- **Get:** An SNMP manager performs this operation to query the SNMP agent of the AP for values of one or more objects.
- **Set:** An SNMP manager performs this operation to set values of one or more objects in the MIB of the SNMP agent of the AP.

SNMP protocol version

The AP is compatible with SNMP V1 and SNMP V2C and adopts the community authentication mechanism. Community name is used to define the relationship between an SNMP agent and an SNMP manager. If the community name contained in an SNMP packet is rejected by a device, the packet is discarded. A community name functions as a password to control SNMP agent access

attempts of SNMP managers.

SNMP V2C is compatible with SNMP V1 and provides more functions than SNMP V1. Compared with SNMP V1, SNMP V2C supports more operations (GetBulk and InformRequest) and data types (such as Counter64), and provides more error codes for better distinguishing errors.

MIB introduction

An MIB adopts a tree structure. The nodes of the tree indicate managed objects. A path consisting of digits and starting from the root can be used to uniquely identify a node. This path is called an object identifier (OID). The following figure shows the structure of an MIB. In the figure, the OID of A is 1.3.6.1.2.1.1, whereas the OID of B is 1.3.6.1.2.1.2.

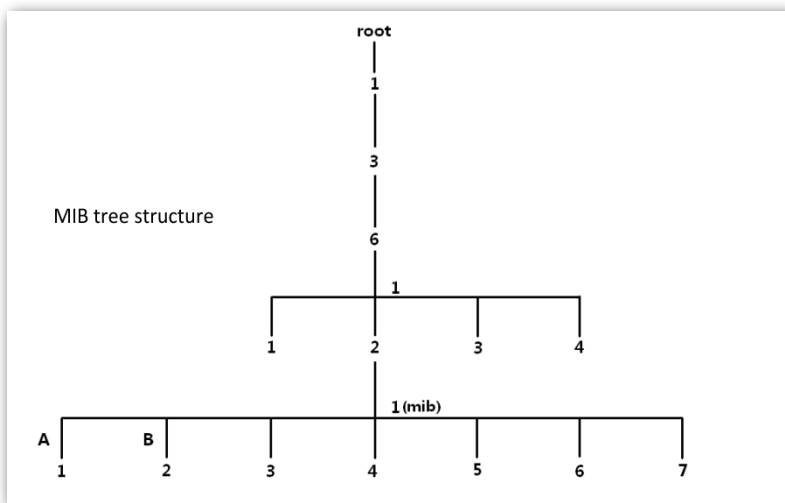

6.2.2 Configuring the SNMP function

To enter the configuration page, choose **Advanced** > **SNMP** first.

Procedure

- Step 1** Enable **SNMP Agent**.
- Step 2** Set related parameters.
- Step 3** Click **Save** to apply your settings.

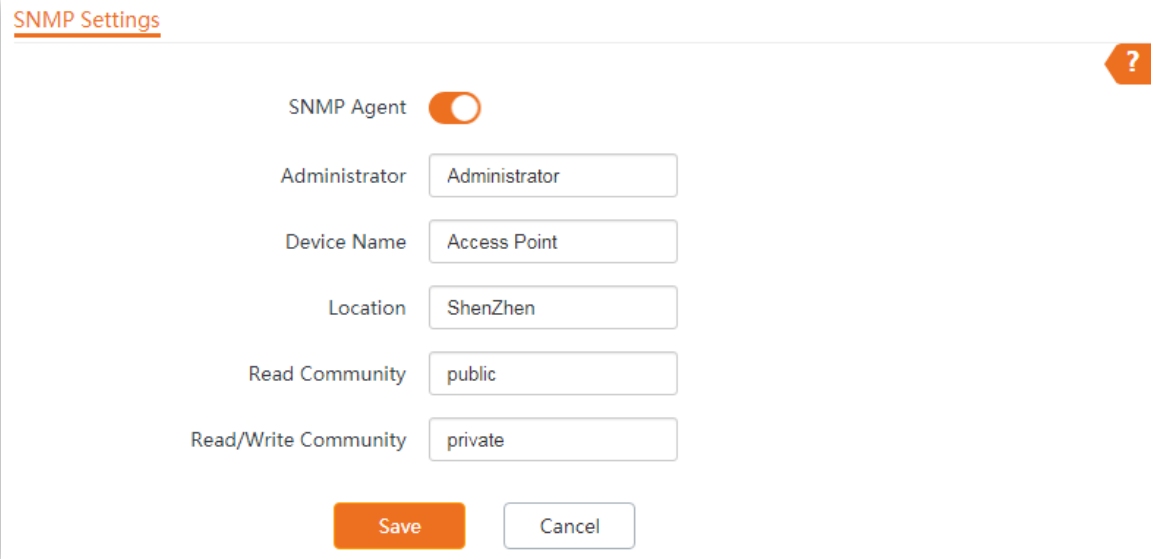

---- End

Parameter description

Parameter	Description
SNMP Agent	It specifies whether to enable the SNMP agent function of the AP. By default, it is disabled. An SNMP manager and the SNMP agent can communicate with each other only when their SNMP versions are the same. Currently, the SNMP agent function of the AP supports SNMP V1 and SNMP V2C.
Administrator	It specifies the administrator's name of the AP. The default name is Administrator . You can modify the administrator's name if required.
Device Name	It specifies the device name of the AP. By default, the device name is Access Point . You can modify it if required.  TIP You are recommended to modify the AP name so that you can identify your AP easily when managing the AP using SNMP.
Location	It specifies the location where the AP is used. You can modify the location according to

Parameter	Description
	your actual situation.
Read Community	<p>It specifies the read password shared between SNMP managers and the SNMP agent. The default password is public.</p> <p>The SNMP agent function of the AP allows an SNMP manager to use the password to read variables in the MIB of the AP.</p>
Read/Write Community	<p>It specifies the read/write password shared between SNMP managers and the SNMP agent. The default password is private.</p> <p>The SNMP agent function of the AP allows an SNMP manager to use the password to read/write variables in the MIB of the AP.</p>

6.2.3 Example of configuring SNMP settings

Networking requirement

- The AP connects to an NMS over an LAN network. This IP address of the AP is 192.168.0.254/24 and the IP address of the NMS is 192.168.0.212/24.
- The NMS uses SNMP V1 or SNMP V2C to monitor and manage the AP.

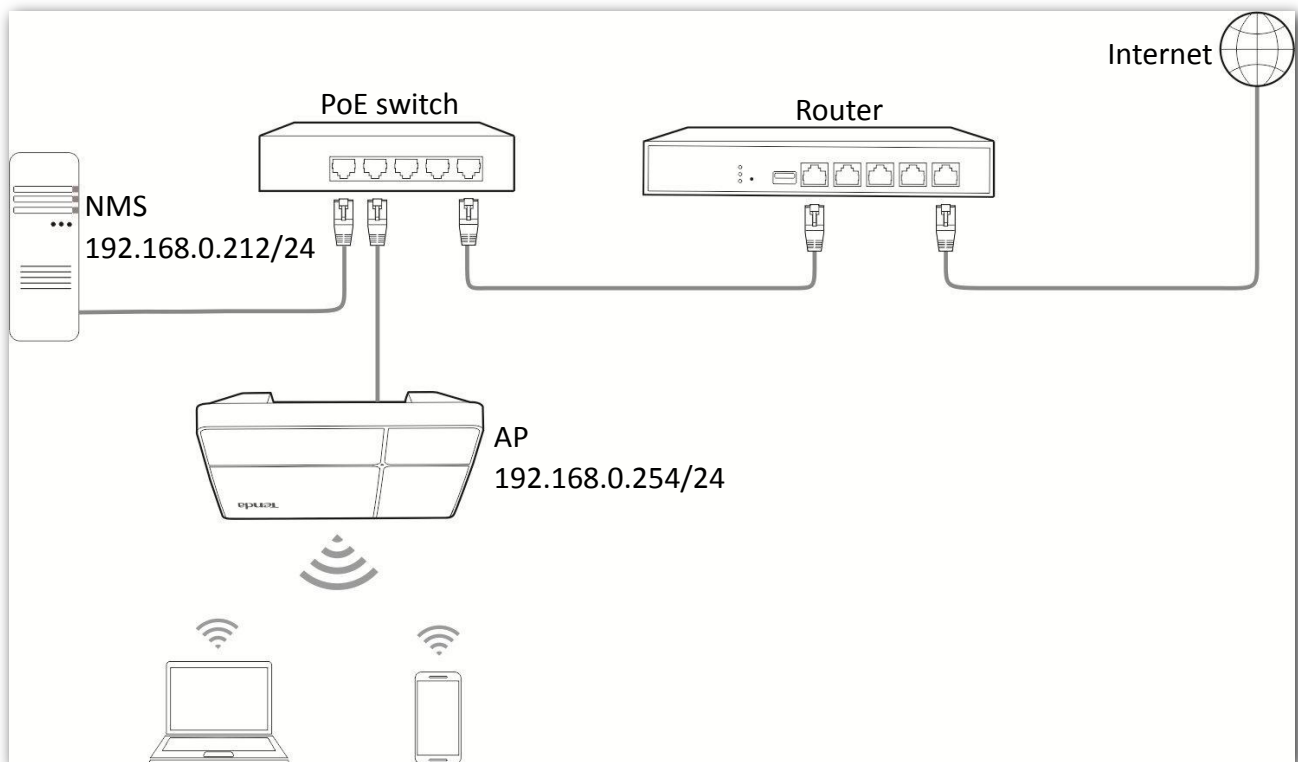

Procedure

Step 1 Configure the AP.

Assume that the administrator name is **Tom**, read community is **Tom**, and read/write community is **Tom123**.

1. Log in to the web UI of the AP and choose **SNMP**.
2. Set **SNMP Agent** to **Enable**.
3. Set the SNMP parameters.
4. Click **Save** to apply your settings.

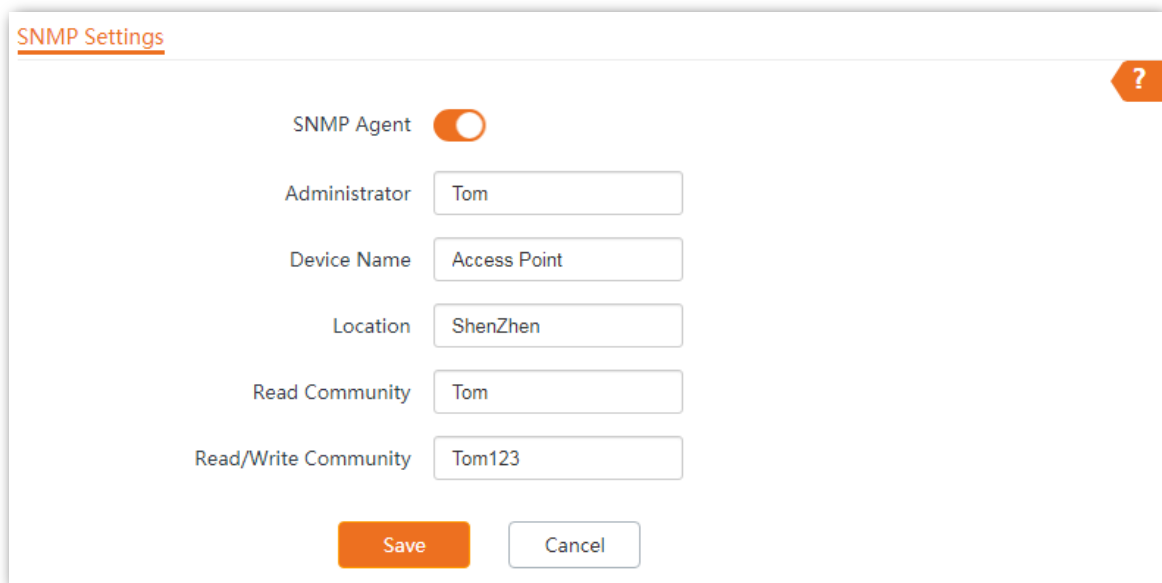

The screenshot shows the 'SNMP Settings' configuration page. At the top right, there is a help icon (a question mark in an orange circle). The settings are as follows:

- SNMP Agent:** A toggle switch that is currently turned on (orange).
- Administrator:** A text input field containing 'Tom'.
- Device Name:** A text input field containing 'Access Point'.
- Location:** A text input field containing 'ShenZhen'.
- Read Community:** A text input field containing 'Tom'.
- Read/Write Community:** A text input field containing 'Tom123'.

At the bottom of the form, there are two buttons: an orange 'Save' button and a white 'Cancel' button with a grey border.

Step 2 Configure the NMS.

On an NMS that uses SNMP V1 or SNMP V2C, set the read community to **Tom** and read/write community to **Tom123**. For details about how to configure the NMS, refer to the user guide of the NMS.

---- End

Verification

After the configuration, the NMS can connect to the SNMP agent of the AP and can query and set some parameters on the SNMP agent through the MIB.

7 Tools

7.1 Date & time

This section introduces how to set the system time and login timeout interval of your AP.

7.1.1 Overview

This function is used to set the system time. To make the time-related functions effective, ensure that the system time of the AP is set correctly.

The section introduces how to:

- Sync with internet time.
- Set system time manually (default).

To access the configuration page, choose **Tools > Date & Time**. See the following figure.

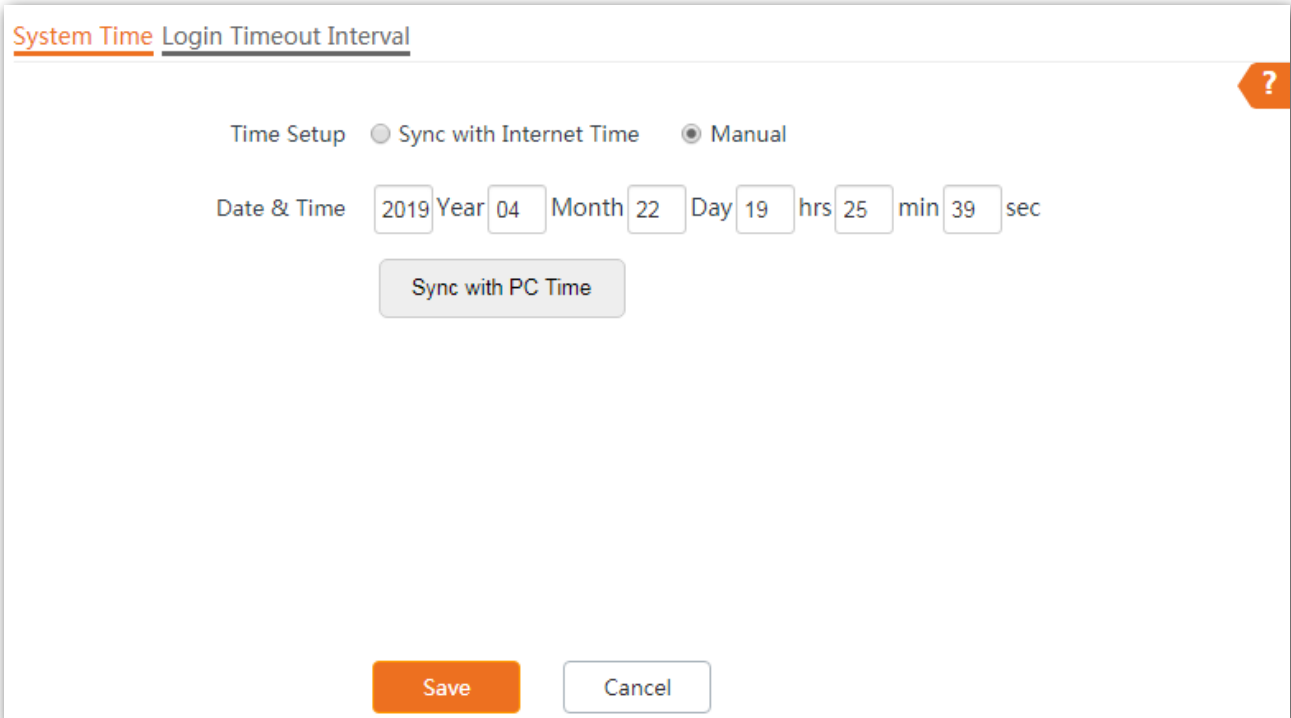

The screenshot shows a configuration page with two tabs: "System Time" (selected) and "Login Timeout Interval". The "Time Setup" section has two radio buttons: "Sync with Internet Time" (unselected) and "Manual" (selected). Below this, the "Date & Time" section displays input fields for Year (2019), Month (04), Day (22), hrs (19), min (25), and sec (39). A "Sync with PC Time" button is located below the date fields. At the bottom of the page, there are "Save" and "Cancel" buttons. A help icon (?) is visible in the top right corner of the configuration area.

7.1.2 Configuring system time

Configuring AP to synchronizing with internet time

With this method, the AP automatically synchronizes its system time with the network time server (NTS). As long as the AP is connecting to the internet, the system time is correct.

Procedure

Step 1 Choose **Tools > Date & Time**.

Step 2 Tick the **Sync with Internet Time** box.

Step 3 Select a value from the **Sync Interval** drop-down list menu as required, which is **30 min** in this example.

Step 4 Choose the **Time Zone** where the AP locates.

Step 5 Click **Save** to apply your settings.

The screenshot shows a configuration window for 'System Time'. The window has two tabs: 'System Time' (selected) and 'Login Timeout Interval'. In the 'System Time' section, there are three main settings: 'Time Setup' with two radio buttons ('Sync with Internet Time' selected and highlighted with a red dashed box, and 'Manual'), 'Sync Interval' with a dropdown menu set to '30 min', and 'Time Zone' with a dropdown menu set to '(GMT+08:00) Beijing, Chongqing, Hong Kong, Urumuqi, Taipei'. At the bottom of the window, there are two buttons: 'Save' (orange) and 'Cancel' (white).

---- End

The AP synchronizes with the internet time every 30 minutes.

Configuring date and time manually

With this method, you need to manually reconfigure the system time each time the AP reboots.

Procedure

Step 1 Choose **Tools > Date & Time**.

Step 2 For manual setup, you can:

Option one: Enter a correct date and time manually.

Option two: Click **Sync with PC Time**, the AP auto-fills the system time of your management computer in the **Date & Time** fields.



Make sure that the system time of your management computer is correct.

Step 3 Click **Save** to apply your settings.

The screenshot shows the 'System Time' configuration page. At the top, there are two tabs: 'System Time' (active) and 'Login Timeout Interval'. Below the tabs, there are two radio buttons for 'Time Setup': 'Sync with Internet Time' and 'Manual'. The 'Manual' radio button is selected and highlighted with a red dashed box. Below the radio buttons, there are input fields for 'Date & Time': '2019' Year, '04' Month, '22' Day, '19' hrs, '25' min, and '39' sec. Below these fields is a button labeled 'Sync with PC Time'. At the bottom of the page, there are two buttons: 'Save' (orange) and 'Cancel' (white).

---- End

7.1.3 Configuring login timeout interval

If you log in to the web UI of the AP and perform no operation within the login timeout interval, the AP logs you out automatically.

Procedure

Step 1 Choose **Tools > Date & Time**, and click the **Login Timeout Interval** tab.

Step 2 Set the login timeout interval as required.

Step 3 Click **Save** to apply your settings.

System Time Login Timeout Interval ?

Login Timeout Interval min(Range: 1 to 60. Default: 5)

---- End

The AP logs you out automatically if you perform no operation within the interval you set here.

7.2 Maintenance

This section introduces how to:

- Reboot the AP manually, or as scheduled.
- Reset the AP either using web UI, or the RESET button.
- Upgrade the AP.
- Back up the AP's configuration to your local computer.
- Restore your previous configurations.
- Control the LED indicator of the AP.

7.2.1 Reboot

If a parameter does not take effect or the AP does not work properly, you can try rebooting the AP to resolve the problem.

The AP supports two rebooting methods:

- [Manual reboot](#): Reboot the AP by clicking the Reboot button.
- [Reboot schedule](#): Let the AP reboot at the specified time or interval you set.



Rebooting the AP disconnects all connections. You are recommended to reboot the AP in spare time.

Manual reboot

Procedure

- Step 1** Choose **Tools > Maintenance**.
- Step 2** Click **Reboot**.
- Step 3** Click **OK** on the pop-up window.

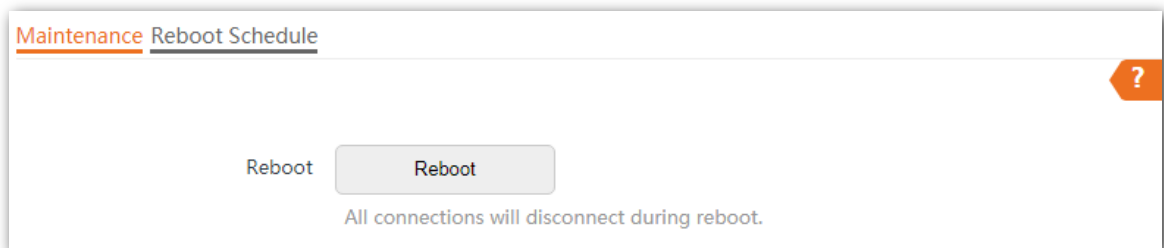

---- End

Wait for the AP completes rebooting.

Reboot schedule

You can let the AP reboot:

- [At interval](#): The AP reboots at the interval you set.
- [At specified time](#): The AP reboots regularly at the time you set.

■ Configuring the AP to reboot at an interval

Step 1 Click **Tools > Maintenance**, and click the **Reboot Schedule** tab.

Step 2 Enable **Reboot Schedule**.

Step 3 Select **Reboot Interval** from the **Type** drop-down list menu.

Step 4 Set **Interval** as required, which is **1440** minutes in this example.

Step 5 Click **Save** to apply your settings.

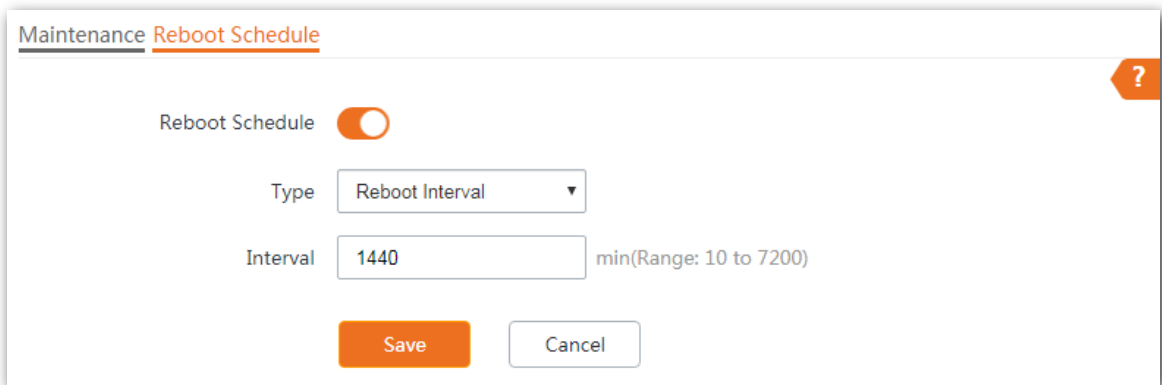

Maintenance **Reboot Schedule**

Reboot Schedule

Type

Interval min(Range: 10 to 7200)

---- End

The AP reboots every 1440 minutes.

■ Configuring the AP to reboot at specified time

Step 1 Click **Tools > Maintenance**, and click the **Reboot Schedule** tab.

Step 2 Enable **Reboot Schedule**.

Step 3 Select **Reboot Schedule** from the **Type** drop-down list menu.

Step 4 **Reboot On**: Select the required day(s) when the AP reboots, which is **Monday** in this example.

Step 5 **Reboot At**: Set the time when the AP reboots, which is **3:00** in this example.

Step 6 Click **Save** to apply your settings.

---- End

The AP reboots at 3:00 every Monday.

7.2.2 Reset

If the internet is inaccessible for unknown reasons, or you forget the login password, you can reset the AP to resolve the problems.

The AP supports two resetting methods:

- [Resetting the AP using web UI.](#)
- [Resetting the AP using the Reset button.](#)

NOTE

- Resetting the AP deletes all your current configurations, and you need to reconfigure the AP again. Therefore, resetting the AP only when necessary.
- If it is necessary to reset the AP, backing up your current configuration first.
- When resetting, do not power off the AP.

Resetting the AP using web UI

- Step 1** Click **Tools > Maintenance**.
- Step 2** Click the **Reset** button.
- Step 3** Click **OK** on the pop-up window.

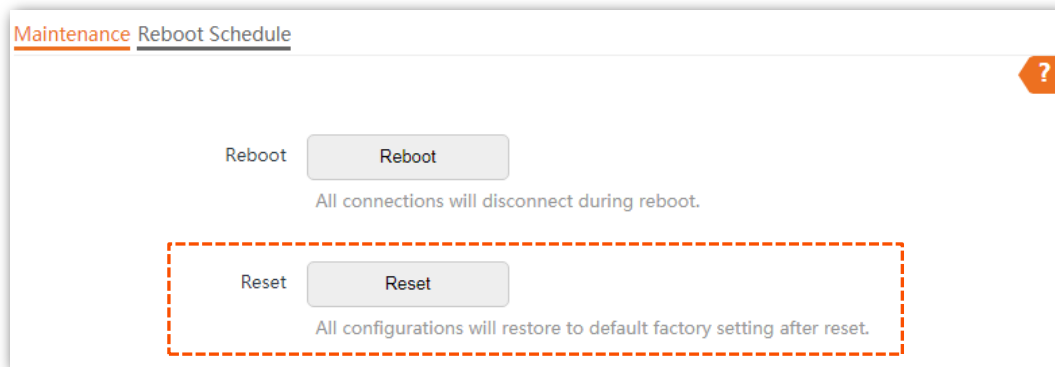

---- End

Resetting the AP using the Reset button

This method enables you to reset the AP without logging in to its web UI.

With the SYS LED indicator blinking, hold down the **RESET** button using a paper clip for about 8 seconds, and release the button when the SYS LED indicator lights up. When the SYS LED indicator blinks, the AP completes resetting.

---- End

7.2.3 Upgrade firmware

This function enables you to upgrade the AP's firmware to get more functions and higher stability.



- To enable your AP to work properly after an upgrade, ensure that the firmware used to upgrade complies with your product model.
- When upgrading, do not power off the AP.

Procedure

- Step 1** Download the latest firmware version for the AP from <http://www.tendacn.com> to your local computer.
- Step 2** Log in to the web UI of the AP, navigate to **Tools > Maintenance**, and locate the **Upgrade Firmware** configuration area.
- Step 3** Click **Upgrade**, select and upload the firmware that has been downloaded to your computer.
- Step 4** Click **Upgrade**. Wait until the progress bar completes.

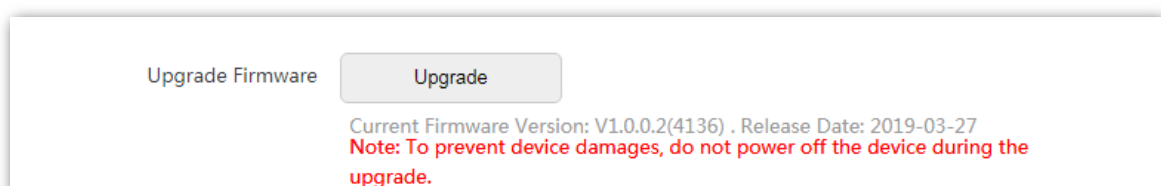



If you upgrade low transmit power version to/from high transmit power version, reset the AP after upgrading completes to apply your settings.

---- End

Wait until the progress bar completes. Then log in to the web UI of the AP again. Click **Status > System Status** and check whether the upgrade is successful according to the **Firmware Version** parameter.

7.2.4 Backup and restoring configurations

The backup function is used to export the current configuration of the AP to your computer. The restore function is used to import a configuration file to the AP.

You are recommended to back up the configuration after it is significantly changed. When the performance of your AP decreases because of an improper configuration, or after you restore the AP to factory settings, you can use this function to restore a configuration that has been backed up.



If you need to apply same or similar configuration to many APs, you can configure one of the APs, back up its configuration, and use the backup configuration file to restore the configuration of other APs.

Backup the current configuration

Step 1 Click **Tools > Maintenance**.

Step 2 Click **Backup/Restore**.

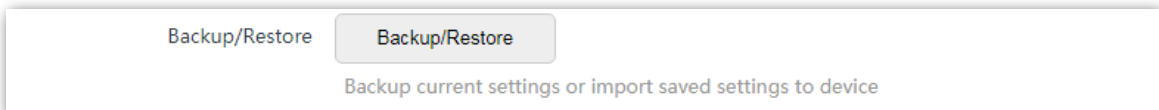

Step 3 Click **Backup** on the pop-up window.

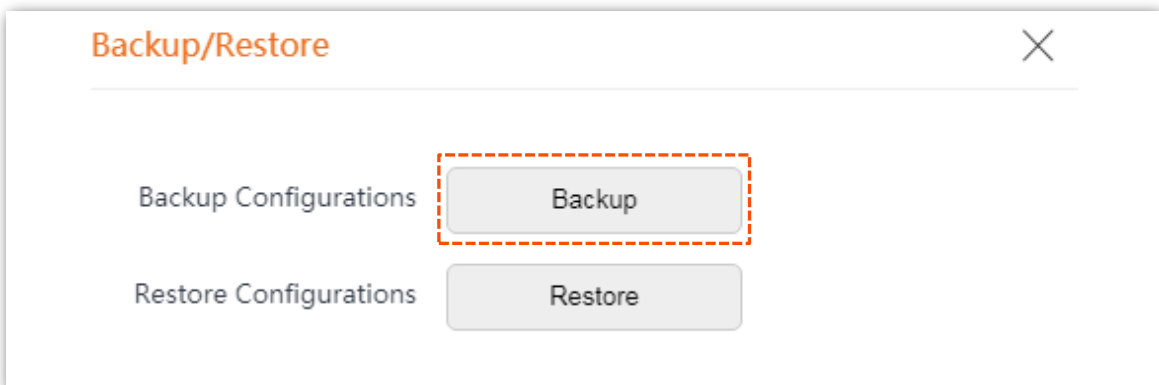

---- End

A configuration file indicated with **APCfm.cfg** will be downloaded.



If the following warning message appears, click **Keep**.

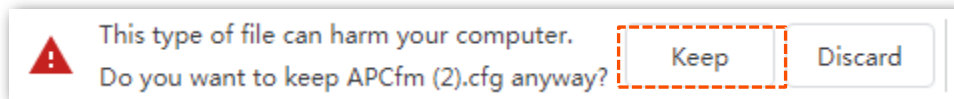

Restoring previous configuration

- Step 1** Click **Tools > Maintenance**.
- Step 2** Click **Backup/Restore**.
- Step 3** Click **Restore** on the pop-up window.

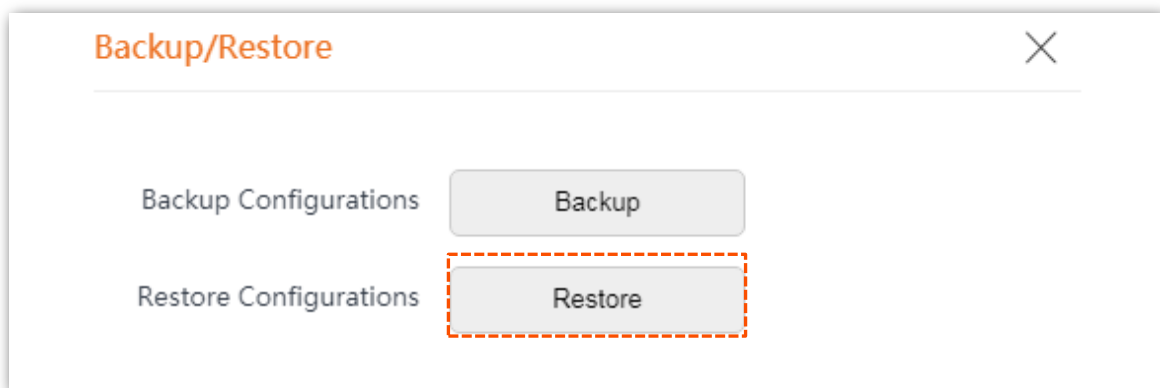

- Step 4** Choose the file you would like to restore.

---- End

Wait until the progress bar completes.

7.2.5 LED indicator control

This function enables you to turn on/off the LED indicator of the AP. By default, the LED indicator is turned on. To turn off the LED indicator, click **Turn off all LED indicators**.

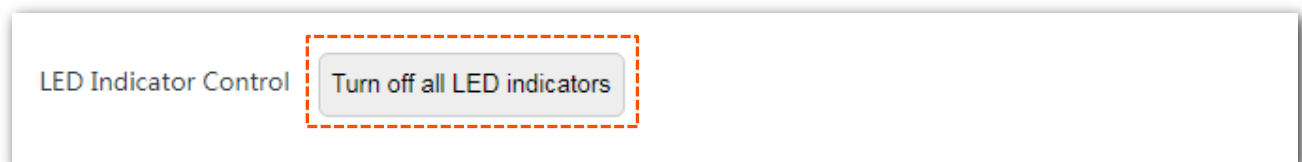

7.3 Account

7.3.1 Overview

The router supports two account types: **Administrator** and **Guest**. The difference between them is their permission.

The **Administrator** account has permission to view and modify the settings. The default username and password for this account are **admin/admin** (both are case-sensitive). You can view and modify it here.

The **Guest** account can only view other than modifying the settings. The default username and password for this account are **user/user** (both are case-sensitive). You can view and modify it here.

To access the configuration page, choose **Tools > Account**.

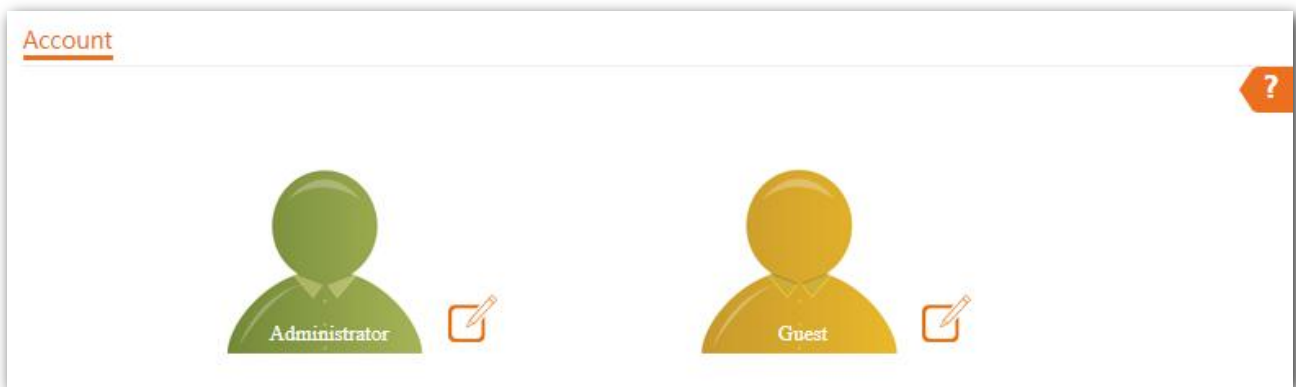

7.3.2 Modifying login password

Step 1 Click **Tools > Account** to enter the configuration page.

Step 2 Locate the account type and modify the password on the pop-up window.

Step 3 Click **Save** to apply your settings.

---- End

Then you will be redirected to the login page. Enter the password corresponding to the account you set just now, and click **Login** to log in to the AP.

7.4 System Log

System logs record information about system running status and the operation you performed on it. When system malfunctions occur, you can use system log for troubleshooting.

The AP also supports **Log Service** that allows you to sync the system logs of the AP to the log server you specified. Therefore, you can use syslog software to view the logs on the server.

7.4.1 Viewing system logs



- System logs will be cleared each time the AP reboots or resets.
- By default, the system only keeps 150 logs that are generated the most recently.

To view system logs, choose **Tools > System Log**.

Click **Refresh** to refresh the current page.

Click **Clear** to clear all logs.

The screenshot shows the 'Logs' section of a web interface. At the top left, there are 'Logs' and 'Log Settings' tabs. Below the tabs are two buttons: 'Refresh' and 'Clear'. To the right of these buttons is a 'Log Type' dropdown menu set to 'All'. A question mark icon is in the top right corner. The main area contains a table with the following data:

ID	Time	Type	Log Content
1	2019-04-22 18:55:14	System	2.4GHz WiFi up
2	2019-04-22 18:55:00	System	2.4GHz WiFi up
3	2011-05-01 00:02:12	System	web 192.168.1.217 login
4	2011-05-01 00:00:08	System	Lan UP
5	2011-05-01 00:00:08	System	AP enter in discovery state.
6	2011-05-01 00:00:08	System	Lan UP
7	2011-05-01 00:00:07	System	check network success
8	2011-05-01 00:00:07	System	System Start Success
9	2011-05-01 00:00:07	System	SNMP Stop
10	2011-05-01 00:00:06	System	DHCP Server Start

At the bottom of the interface, there is a pagination bar showing '10' in a dropdown, 'in total/Page 12 in total', and navigation buttons for 'Previous', '1', '2', and 'Next'.

7.4.2 Modifying number of logs to be displayed on Web UI

Choose **System Log**, and then click the **Log Settings** page first.

Procedure

Step 1 Enable **Log Service**.

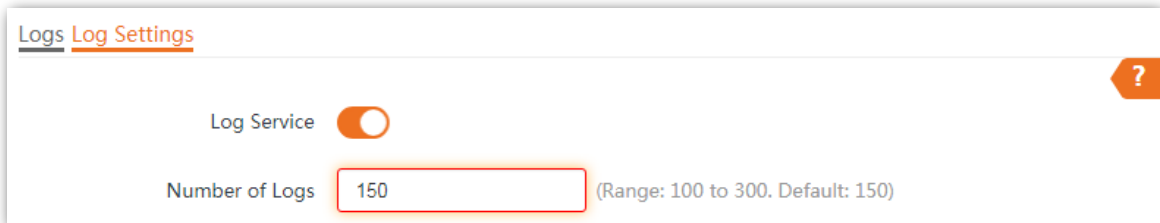

The screenshot shows the 'Log Settings' page. At the top, there is a breadcrumb 'Logs Log Settings' and a help icon. Below that, the 'Log Service' toggle is turned on. The 'Number of Logs' is set to 150 in a text input field, with a range of 100 to 300 and a default of 150.

Step 2 Modify the **Number of Logs** as required.

Step 3 Click **Save** at the bottom on this page to apply your settings.

---- End

7.4.3 Sync system logs of the AP to a log server

With the **Log Service** function enabled, you can sync the system logs of the AP to the log server you specified. Therefore, you can use syslog software to view the AP's system logs on the log server.

Procedure

Step 1 Choose **Tools > System Log**, and click the **Log Settings** tab.

Step 2 Enable **Log Service**, and click **Save** to apply your settings.

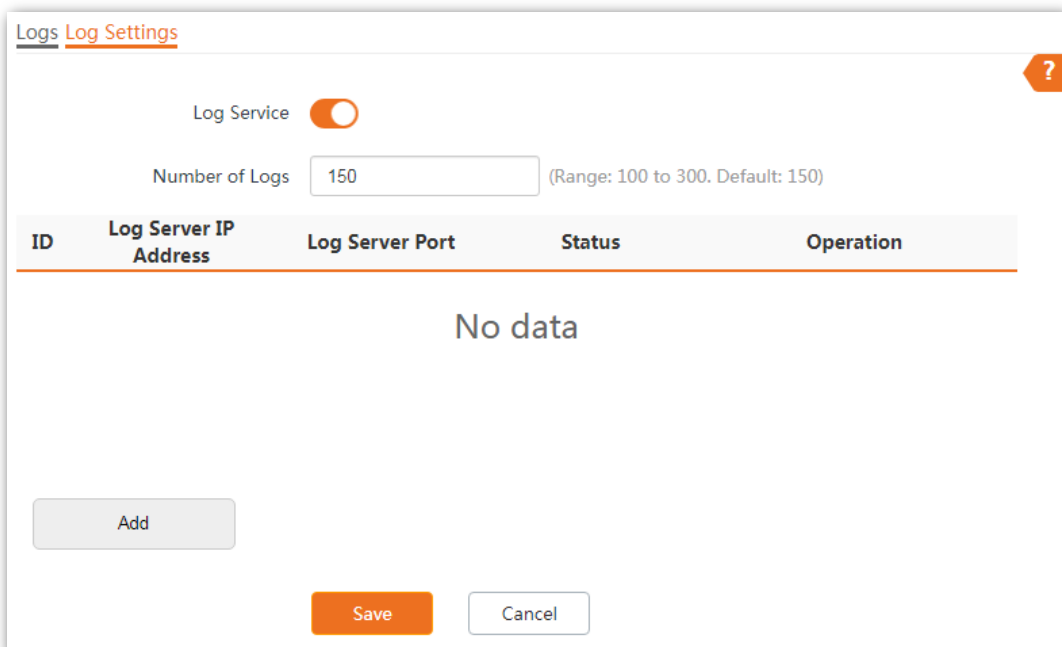

The screenshot shows the 'Log Settings' page. At the top, there is a breadcrumb 'Logs Log Settings' and a help icon. Below that, the 'Log Service' toggle is turned on. The 'Number of Logs' is set to 150 in a text input field, with a range of 100 to 300 and a default of 150. Below this is a table with the following columns: ID, Log Server IP Address, Log Server Port, Status, and Operation. The table is currently empty, displaying 'No data'. At the bottom, there is an 'Add' button, a 'Save' button, and a 'Cancel' button.

ID	Log Server IP Address	Log Server Port	Status	Operation
No data				

Step 3 Click **Add**. The following window appears.

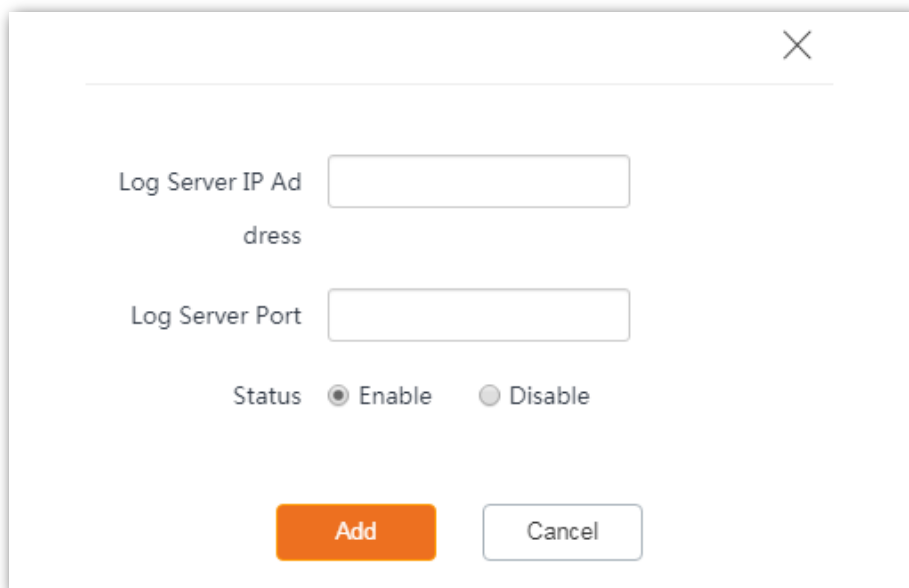

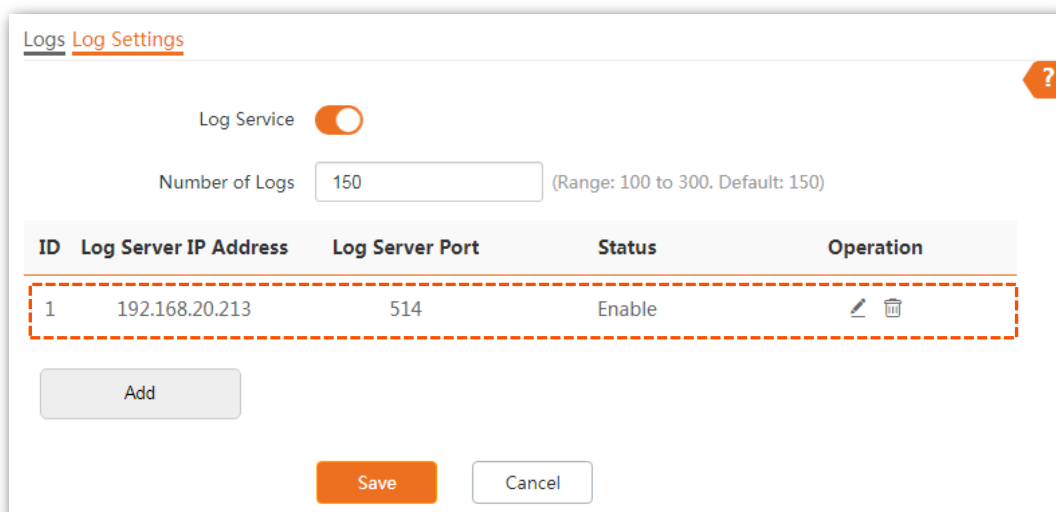

A dialog box with a close button (X) in the top right corner. It contains two text input fields: "Log Server IP Address" and "Log Server Port". Below the fields is a "Status" section with two radio buttons: "Enable" (selected) and "Disable". At the bottom are two buttons: "Add" (orange) and "Cancel" (white).

Step 4 Enter the **Log Server IP Address** and **Log Server Port** as required, which is **192.168.20.213** and **514** in this example. And click **Add**.



The "Log Settings" page shows the "Log Service" toggle switch turned on. The "Number of Logs" is set to 150, with a range of 100 to 300 and a default of 150. Below is a table with columns: ID, Log Server IP Address, Log Server Port, Status, and Operation. The first row is highlighted with a dashed orange border and contains: 1, 192.168.20.213, 514, Enable, and edit/delete icons. At the bottom are "Add", "Save", and "Cancel" buttons.

ID	Log Server IP Address	Log Server Port	Status	Operation
1	192.168.20.213	514	Enable	 

---- End

You can view the system log of the AP remotely on the third-party log server software you use.

7.5 Diagnostic tool

7.5.1 Overview

The AP supports Ping command, which is used to check whether or not the connection between the AP and a specified host is correct and the connection quality when facing network reachability issues.

7.5.2 Executing Ping command to detect connection quality

Assume that you need to check the connection quality between the AP and its upstream router:

Step 1 Choose **Tools > Diagnostic Tool** to enter the configuration page.

Step 2 Enter the IP address of its upstream router in the **Target IP/Domain Name** box, which is **192.168.1.1** in this example.



Step 3 Click **ping**, or press **Enter** (Windows) or **Return** (Mac) on keyboard.

---- End

Wait a moment. The Ping result is displayed in the black square. See the following figure:

Diagnostic Tool



Enter an IP address (eg. 192.168.0.254) or a domain name (eg. www.google.com)

Target IP/Domain Name

```
Ping 192.168.1.1(192.168.1.1):56 data bytes
64 bytes from 192.168.1.1: seq=0 ttl=64 time=0.591 ms
64 bytes from 192.168.1.1: seq=1 ttl=64 time=0.604 ms
64 bytes from 192.168.1.1: seq=2 ttl=64 time=0.588 ms
64 bytes from 192.168.1.1: seq=3 ttl=64 time=0.547 ms

--- 192.168.1.1 ping statistics ---
4 packets transmitted, 4 packets recieved, 0% packet loss
roud-trip min/avg/max = 0.547/0.583/0.604 ms
```

7.6 Uplink check

7.6.1 Overview

In AP mode, the AP connects to its upstream network using the LAN port. If a critical node between the LAN port and the upstream network fails, the AP as well as the wireless devices connected to the AP cannot access the upstream network. If uplink detection is enabled, the AP regularly pings specified hosts through the LAN port. If all the hosts are not reachable, the AP stops its wireless service and wireless devices cannot find the SSIDs of the AP. The device can reconnect to the AP only after the connection between the AP and the upstream networks is recovered.

If the uplink of the AP with uplink check enabled is faulty, wireless devices can connect to the upstream network through another nearby AP that works properly.

See the following topology (The LAN port serves as the uplink port).

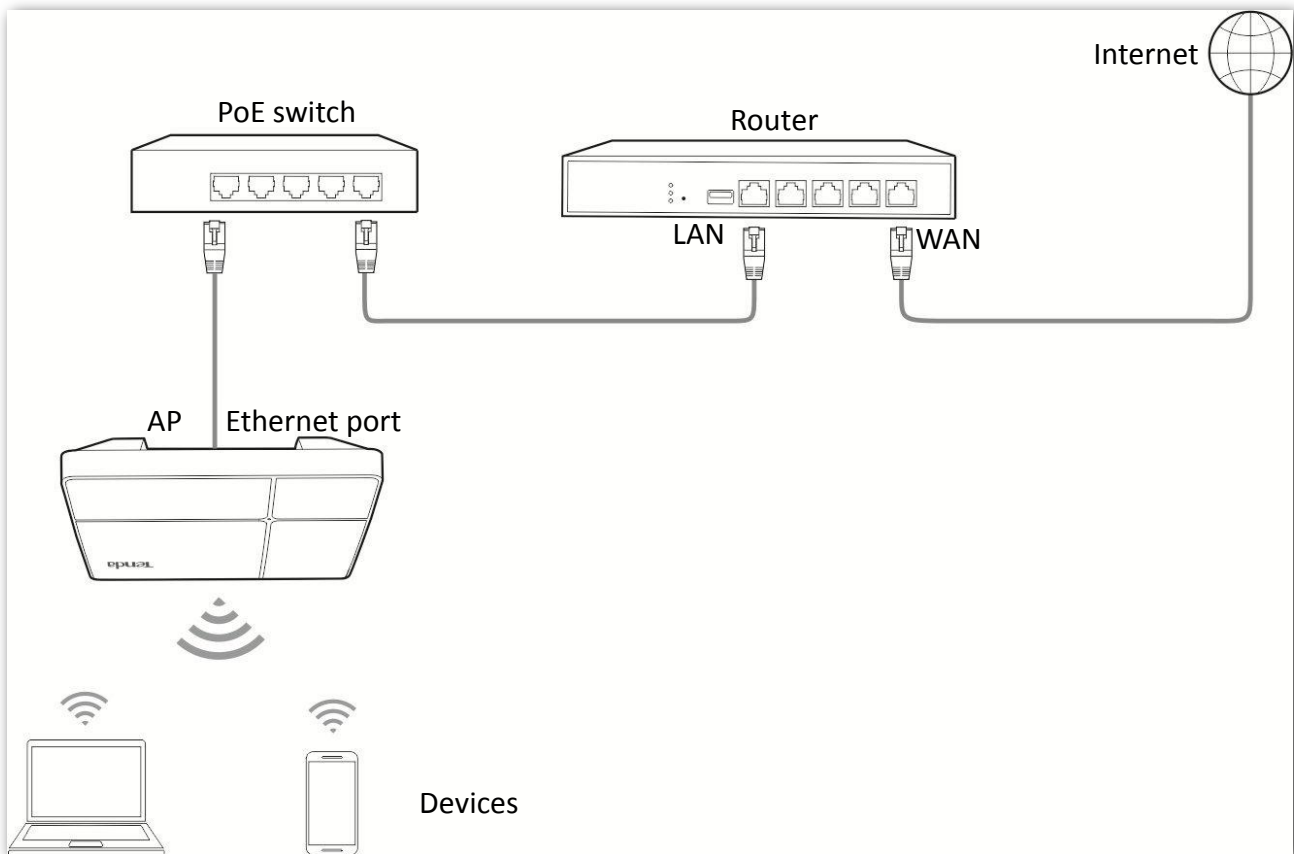

7.6.2 Configuring uplink detection

To enter the configuration page, choose **Tools > Uplink Detection** first.

Procedure

Step 1 Enable **Uplink Detection**.

Step 2 Enter the LAN IP address of **Host1** and **Host2** to ping in the corresponding box.



Both **Host1 to Ping** and **Host2 to Ping** are mandatory. If you have only one host to ping, repeat the IP address of Host1 in **Host2 to Ping** box.

Step 3 Enter the interval at which the AP detects its uplink in **Ping Interval** box.

Step 4 Click **Save** to apply your settings.

The screenshot shows a configuration window titled "Uplink Detection" with a help icon in the top right corner. The "Uplink Detection" toggle switch is turned on. Below it, there are three input fields: "Host1 to Ping" with the value "192.168.1.125", "Host2 to Ping" with the value "192.168.1.1", and "Ping Interval" with the value "10". A note next to the "Ping Interval" field reads "min(Range: 10 to 100. Default: 10)". At the bottom of the window are two buttons: "Save" and "Cancel".

---- End

Appendix

A.1 Configuring a static IP address for your computer (Example: Windows 7)

Procedure

Step 1 Right-click  in the lower-right corner of the desktop and choose **Open Network and Sharing Center**.

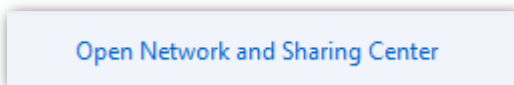

Step 2 Click **Local Area Connection**.

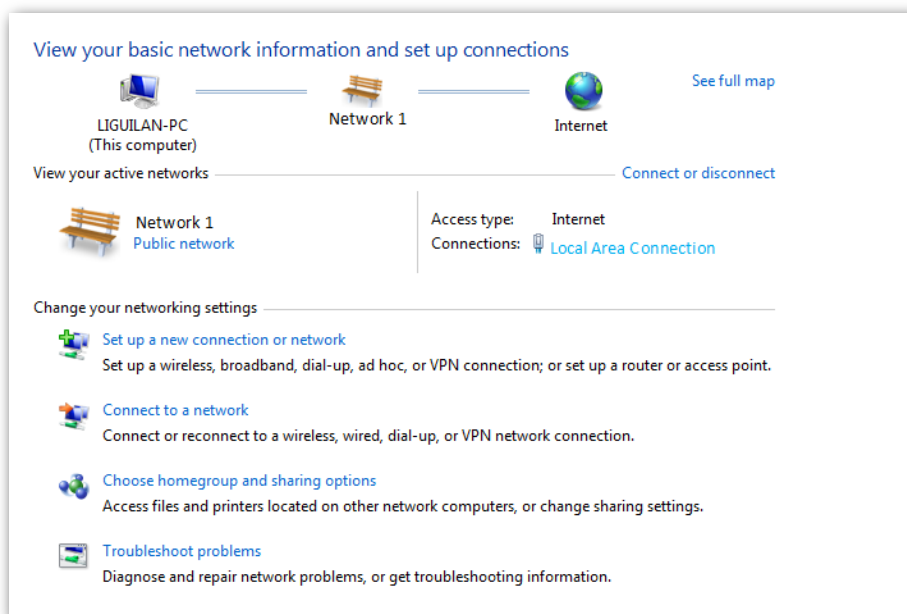

Step 3 Click **Properties**.

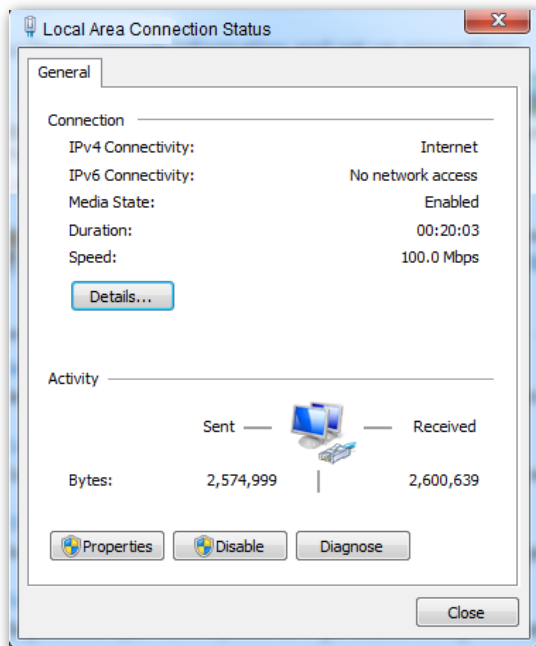

Step 4 Double-click **Internet Protocol Version 4 (TCP/IPv4)**.

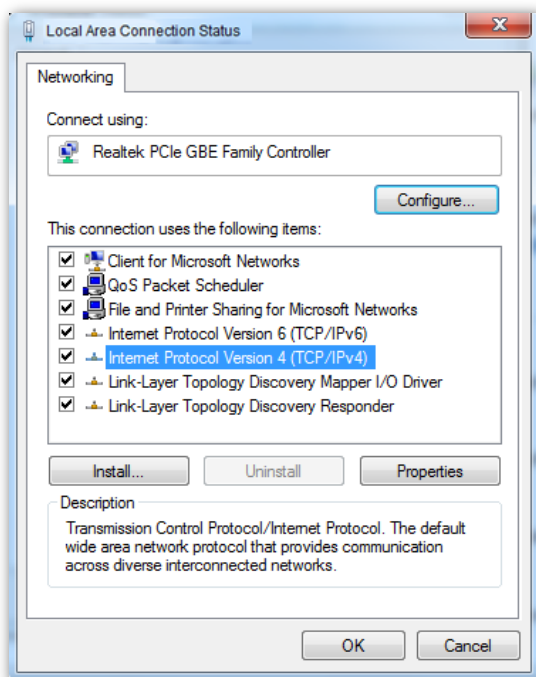

Step 5 Select **Use the following IP address** and **Use the following DNS server address**.

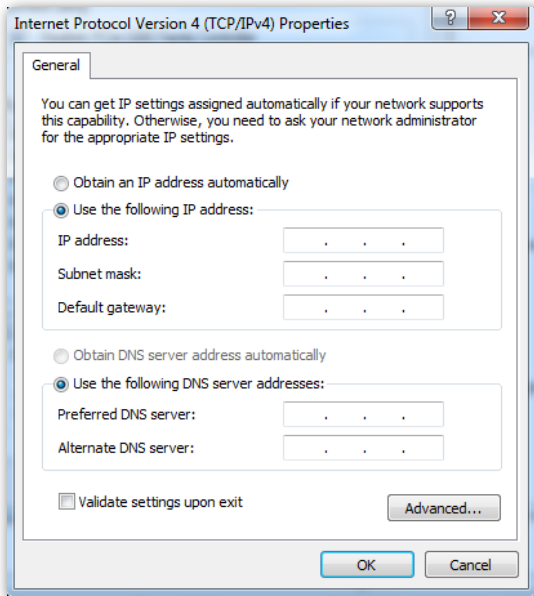

Step 6 **IP address, Subnet mask:** Set a static IP address, subnet mask for your computer, which is **192.168.0.10** and **255.255.255.0** in this example, and click **OK**.

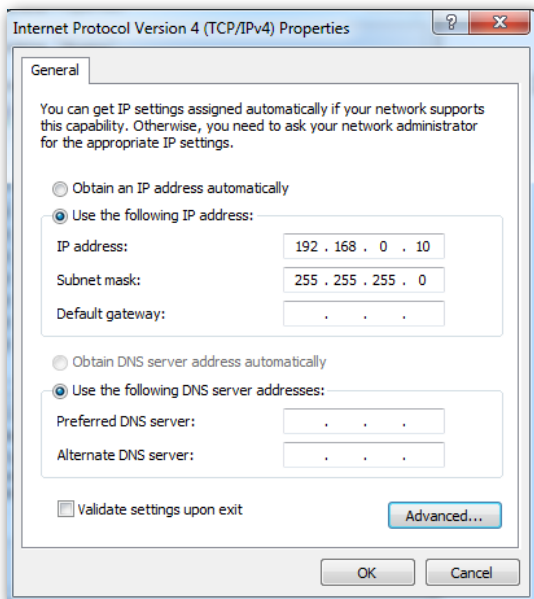

---- End

Configuration succeeds. You can check whether your configuration is successful on the **Network Connection Details** page. Procedure is as follows:

Step 1 Right-click  in the lower-right corner of the desktop and choose **Open Network and Sharing Center**.

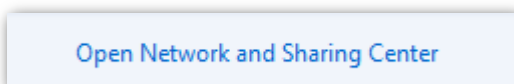

Step 2 Click **Local Area Connection**.

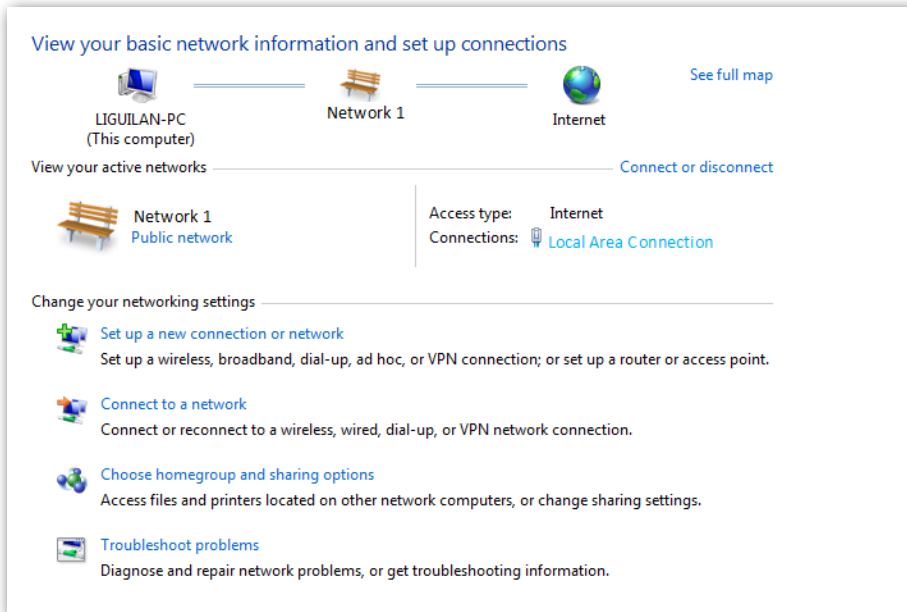

Step 3 Click **Details**.

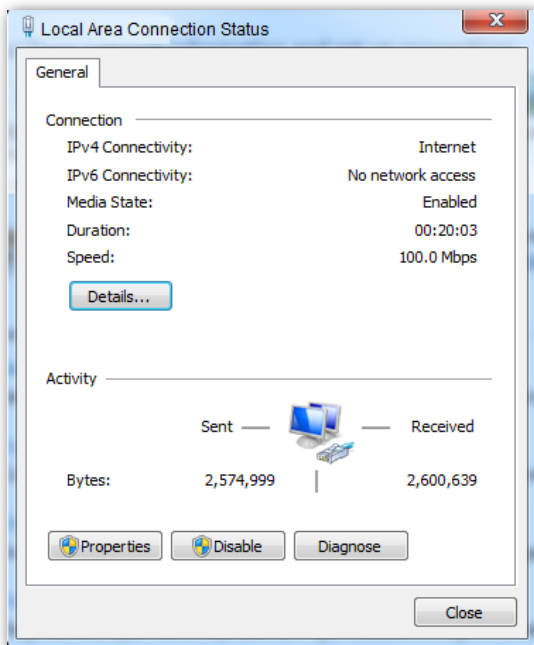

Step 4 Check whether your configuration is successful on the **Network Connection Details** page. Parameters in **IPv4 Address**, **IPv4 Subnet Mask** represent the IP address, subnet mask of your computer.

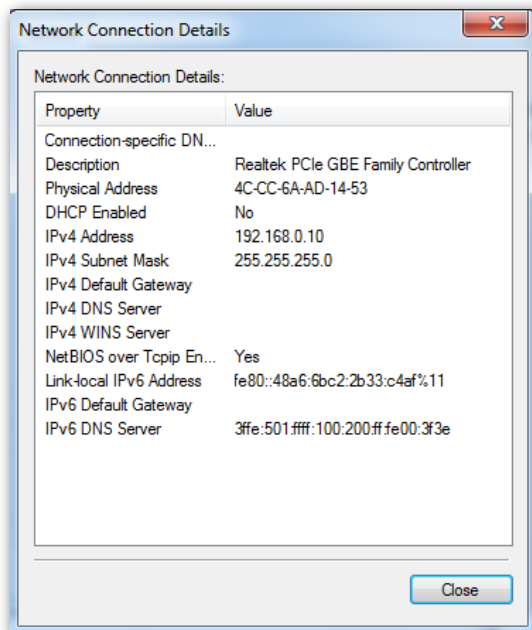

A.2 FAQ

Q1: I cannot access the web UI of the AP after entering 192.168.0.254. What should I do?

A1: Try the following solutions:

- Ensure that all your Ethernet cables are properly connected.
- If there is no Tenda AC or Tenda router with AP functionality in the network, ensure that the IP address of your computer has been set to 192.168.0.X (X: 2 to 253), and the IP address is not used by any other devices in the same network.
- Clear the cache of your web browser, or replace the web browser.
- Disable the firewall of your computer.
- Replace your computer.
- If two or more APs are connected in the network without an Tenda AC or Tenda router with AP functionality, an IP address conflict may happen. You should leave only one AP in the network first and set a new IP address 192.168.0.X (X: 2 to 253) for the AP. Then repeat this procedure to modify the IP addresses of the other APs. Meanwhile, make sure that the IP address of your computer is in the same network segment with your APs' new IP addresses. Then try logging in to the web UI of your APs using their new IP addresses.
- If the AP has been managed by an Tenda AC or Tenda router with AP functionality, the AP's IP address may be no longer 192.168.0.254. In that case, go to the web UI of the **AC/router** to view the new IP address of the AP, and then log in to the AP's web UI using the new IP address.
- If the problem persists, reset the AP, and then try logging in again.

Q2: My access controller (AC) cannot find my AP. What should I do?

A2: Try the following solutions:

- Ensure that all the devices in the network are connected properly and the LED of the AP blinks.
- If VLANs have been defined in your network, verify that the corresponding VLAN has been added to your AP controller.
- [Reboot](#) your AP.
- [Upgrade firmware](#) your AP to the latest version.
- [Reset](#) your AP.

A.3 Default parameter values

The following table lists the default parameter values of the AP.

Parameter		Default Value	
Login	Login IP address	192.168.0.254	
	Account	Administrator	User Name/Password: admin/admin (case-sensitive)
		Guest	User Name/Password: user/user (case-sensitive)
Quick Setup	Working Mode	AP	
LAN Setup	IP Address Type	Static IP	
	IP Address	192.168.0.254	
	Subnet Mask	255.255.255.0	
	Default Gateway	0.0.0.0	
	Primary DNS	0.0.0.0	
	Secondary DNS	0.0.0.0	
	Device Name	Access Point	
	Optimize Ethernet for	Faster Speed (Auto Negotiation)	
DHCP Server	DHCP Server	Disable	
	Start IP Address	192.168.0.100	
	End IP Address	192.168.0.200	
	Subnet Mask	255.255.255.0	
	Gateway Address	192.168.0.1	
	Primary DNS	192.168.0.1	
	Lease Time	1 day	
SSID	SSID	2.4 GHz	<p>The AP allows 8 SSIDs on the 2.4 GHz band. SSID is Tenda_XXXXXX. XXXXXX indicates the last 6 digits of the AP's LAN MAC address with a range of XXXXXX~XXXXXX+7.</p> <p>The first (primary) SSID in the drop-down-list box is enabled by default, and the other SSIDs are disabled.</p>
		5 GHz	The AP allows 4 SSIDs on the 5 GHz band. SSID is Tenda_XXXXXX_5G. XXXXXX indicates the

Parameter		Default Value	
		last 6 digits of the AP's LAN MAC address with a range of XXXXXX+8~XXXXXX+B. The first (primary) SSID in the drop-down-list box is enabled by default, and the other SSIDs are disabled.	
	Broadcast SSID	Enable	
	Isolate Client	Disable	
	Isolate Client	Disable	
	WMF	Disable	
	Max. Number of Clients	48	
	Chinese SSID Encoding	UTF-8	
	Security Mode	None	
RF Settings	Wireless Network	Enable	
	Network Mode	2.4 GHz	11b/g/n
		5 GHz	11ac
	Channel	Auto	
	Channel Bandwidth	2.4 GHz	20MHz
		5 GHz	80MHz
	Lock Channel	Enable	
	Lock Power	Enable	
	Preamble	Long Preamble	
Short GI	Enable		
Suppress Broadcast Probe Response	Disable		
RF Optimization	Beacon Interval	100 ms	
	Fragment Threshold	2346	
	RTS Threshold	2347	
	DTIM Interval	1	
	RSSI Threshold	-90 dBm	
	Signal Transmission	Coverage-oriented	

Parameter		Default Value	
	Prioritize 5 GHz	Disable	
	5 GHz Threshold	-80 dBm	
	Air Interface Scheduling	Enable	
	Anti-interference Mode	3 (Suppress critical interference)	
	APSD	Disable	
	MU-MIMO	Enable	
	Client Timeout Interval	10 minutes	
	Mandatory Rate	2.4 GHz	1, 2, 5.5, 11
		5 GHz	6, 12, 24
	Optional Rate	2.4GHz	1, 2, 5.5, 6, 9, 11, 12, 18, 24, 36, 48, 54
		5GHz	6, 9, 12, 18, 24, 36, 48, 54
WMM	No ACK	Disable	
	WMM Optimization	Custom	
Access Control		Disable	
Advanced Settings	Identify Client Type	Disable	
	Broadcast Packet Filter	Disable	
QVLAN Settings	QVLAN Status	Disable	
	PVID	1	
	Management VLAN	1	
	2.4GHz SSID VLAN ID	1000	
	5GHz SSID VLAN ID	1000	
Deployment Mode		Local	
SNMP	SNMP Agent	Disable	
	Administrator	Administrator	
	Device Name	Access Point	
	Location	ShenZhen	
	Read Community	public	

Parameter		Default Value	
	Read/Write Community	private	
Tools	Date & Time	System Time	Manual
		Login Timeout Interval	5 minutes
	Log records	150	
	Log Service	Disable	
	Reboot Schedule	Disable	
	LED indicator Control	Enable	
	Uplink Detection	Disable	